

This version of draft plans to be annexed to the Sub-Deed of Mutual Covenant and Management Agreement (“SDMC”) are subject to amendment(s) from time to time in the future.

此版本的將夾附於分公契及管理協議(「分公契」)的圖則擬稿在將來可能會不時更改。

Dated _____ 20

MTR CORPORATION LIMITED

as the registered owner

and

[_____]

as the Purchaser

and

[_____]

as the Manager

SUB-DEED OF MUTUAL COVENANT

and

MANAGEMENT AGREEMENT

in respect of

**Phase II erected on
part of Site A of Kowloon Inland Lot No.11264**

Draft 16 (Approved)

2023.11.14

Deacons

5th Floor

Alexandra House

16-20 Chater Road

Central, Hong Kong

hongkong@deacons.com

www.deacons.com

Tel : +852 2825 9211

Fax : +852 2810 0431

LC:WW:TSCARY 550565

SUB-DEED OF MUTUAL COVENANT

INDEX

SECTION A : PARTIES AND RECITALS

- Date
- Parties
- Recitals
 - 1. Supplemental
 - 2. Development
 - 3. Allocation of Shares
 - 4. Assignment
 - 5. Purpose of Deed
 - 6. Approval

OPERATIVE PARTS

SECTION B : DEFINITIONS

SECTION C : RIGHTS OF OWNERS

- 1. Rights attaching to each Share
- 2. Rights of MTR
- 3. Rights of Purchaser
- 4. Disposal restrictions

SECTION D : OBLIGATIONS OF OWNERS AND POWERS OF MANAGER

- 1. Owners and Manager to comply
- 2. Owners to observe restrictive covenants
- 3. Management Charges
- 4. Assignment of Common Areas and Common Services and Facilities
- 5. Phase II Residential Units with open kitchen
- 6. Ownership and maintenance of Non-Common EV Facilities
- 7. Compliance with ordinances, etc. in respect of Non-Common EV Facilities
- 8. Compliance with ordinances, etc. in respect of EV Facilities for Visitors' Car Parking Spaces
- 9. Electricity supply
- 10. Maintenance of Noise Mitigation Measures in Phase II
- 11. Curtain walls and windows

SECTION E : MEETINGS OF THE OWNERS OF PHASE II

- 1. Meetings of the Owners
- 2. Annual Meeting
- 3. Convening of meeting
- 4. Notice
- 5. Quorum
- 6. Chairman
- 7. Minutes

8. Voting
9. Resolutions binding on Owners
10. Accidental omission of notice
11. Resolutions requiring special majority
12. Audit of annual accounts
13. Meetings before completion of Phase IIB

SECTION F : PHASE II OWNERS SUB-COMMITTEE

1. Number of members
2. Quorum
3. Eligibility for appointment
4. Election of members
5. Officers
6. Tenure of office
7. Votes of members
8. Power to make rules
9. Manager to be invited
10. Power to call meeting

SECTION G : PHASE II HOUSE RULES

1. Phase II House Rules first in force
2. Making and amendment of Phase II House Rules
3. Phase II House Rules to be posted on notice boards

SECTION H : INTERPRETATION AND MISCELLANEOUS

1. Marginal notes, headings and index
2. Plurals and genders
3. Service of notices
4. Covenants to run with Land
5. Chinese translation
6. The Ordinance
7. Phase II Works and Installations
8. Paragraphs 7(7) and 7(8) of Schedule 7 to the Ordinance

**FIRST SCHEDULE PART I ALLOCATION OF SHARES
PART II ALLOCATION OF MANAGEMENT UNITS**

SECOND SCHEDULE PART I EASEMENTS

1. Right to pass
2. Rights of Owners of the Phase II Residential Units
3. Rights of Owners of the Phase II Car Parking Spaces
4. Right of way for access to and from security management office in Phase II
5. Right of way for access to and from owners' committee office

PART II EXCEPTIONS AND RESERVATIONS

1. Rights of other Owners
2. Rights of Manager under Principal Deed

THIRD SCHEDULE RESTRICTIONS AND PROHIBITIONS

1. Not to partition
2. User
3. Not to make alterations or additions
4. Phase II Balconies and Phase II Utility Platforms
5. Not to hang washing
6. Not to exhibit signs
7. Not to misuse lavatories
8. Not to obstruct Common Areas
9. No erection of metal grilles and shutters
10. Not to obstruct driveways
11. Visitors' Car Parking Spaces
12. Disabled Car Parking Spaces
13. Loading and unloading bays
14. Phase II Greenery Area
15. Void
16. Height control and planting requirement

FOURTH SCHEDULE PHASE II HOUSE RULES

FIFTH SCHEDULE PHASE II WORKS AND INSTALLATIONS

**SIXTH SCHEDULE PHASE II BALCONIES
PHASE II UTILITY PLATFORMS**

EXECUTION

SECTION A

PARTIES AND RECITALS

- Date** **THIS DEED** is made the _____ day of _____ .
- Parties** **BETWEEN**
- (1) **MTR CORPORATION LIMITED** (香港鐵路有限公司) whose registered office is situated at MTR Headquarters Building, Telford Plaza, Kowloon Bay, Kowloon, Hong Kong (“MTR” which expression shall where the context so admits include its successors and assigns) and any reference to MTR in this Deed shall be construed as reference to MTR in its capacity as the registered owner of the Units in Phase II of the Estate (except the First Assigned Premises) but not further or otherwise;
- (2) [_____] of [_____] Hong Kong (the “Purchaser” which expression shall where the context so admits include its successors and assigns); and
- (3) [_____] whose registered office is situated at [_____] (the “Manager” which expression shall where the context so admits include its successors and assigns).
- Recitals** **WHEREAS :-**
- Supplemental** 1. This Deed is supplemental to the Principal Deed relating to the Development.
- Development** 2. Phase II of the Estate has been constructed on part of Site A and is now known as [_____].
- Allocation of Shares** 3. For the purpose of distribution and sale, 690,000 equal undivided 1,860,250th Shares in the Land have been allocated to Phase II in the manner set out in Part I of the First Schedule hereto.
- Assignment** 4. By an Assignment bearing even date herewith executed immediately prior to this Deed and made between MTR of the one part and the Purchaser of the other part, the First Assigned Premises was assigned to the Purchaser by MTR.
- Purpose of Deed** 5. The parties hereto have agreed to enter into this Deed for the purposes of :-
- (a) defining and regulating the rights, interests and obligations of themselves and all subsequent Owners in respect of Phase II of the Estate;
 - (b) making specific provisions for the management of Phase II;
 - (c) appointing [_____] as the Manager to exercise the powers and perform the duties on its part for the period and on the terms and conditions herein contained; and
 - (d) identifying those parts of Phase II which will form part of the Common Areas and the Common Services and Facilities under the Principal Deed.
- Approval** 6. The Director has given his approval to this Deed in accordance with the Government Grant.

OPERATIVE PARTS

NOW THIS DEED WITNESSETH that the parties hereto have agreed and **DO HEREBY COVENANT** with each other as follows to the intent that this Deed shall enure to the benefit of and shall bind each of them and their respective successors in title and persons deriving title under or through them or any of them and all persons who may hereafter during the Term become an Owner.

SECTION B

DEFINITIONS

1. Terms (other than those set out in Clause 2 hereof) defined in the Principal Deed shall have the same meaning when used in this Deed.

2. In this Deed the following words and expressions shall have the meanings ascribed to them except where the context otherwise requires :-

- “Authorized Person”** means Mr. Cheung Man Ching, Anthony of Ronald Lu & Partners (Hong Kong) Limited who is appointed by MTR under section 4(1)(a) of the Buildings Ordinance (Cap.123 of the Laws of Hong Kong) as a co-ordinator of building works for Phase II, which expression shall include any other authorized person or persons as defined in section 2(1) of the Buildings Ordinance (Cap.123 of the Laws of Hong Kong) appointed or nominated under section 4(2) of the Buildings Ordinance (Cap.123 of the Laws of Hong Kong) in the place of the said Mr. Cheung Man Ching, Anthony;
- “Common EV Facilities”** means all such facilities installed or to be installed within the Phase II Car Park Common Areas for the common use and benefit of the Owners of the Phase II Car Parking Spaces for the purpose of or in relation to the charging of electric motor vehicles or electric motor cycles licensed under the Road Traffic Ordinance (Cap.374 of the Laws of Hong Kong), any regulations made thereunder and any amending legislation, and parking at any of the Phase II Car Parking Spaces; such facilities shall not serve any of the Phase II Car Parking Spaces exclusively or belong to any of the Owners of the Phase II Car Parking Spaces and shall include, but not limited to, such wires, cables, ducts, trunking, electric meters, base box, socket outlets, locks, covers and such other security and/or protective devices, equipment, apparatus and such other electrical or other installations or otherwise for or in relation to such purpose;
- “Covered Walkway”** means the covered walkways (including canopies and associated structures thereof) wholly located in Site A forming part of the Phase II Residential Common Areas; and the Covered Walkway is for identification purpose only as shown and delineated by black broken lines on the plan (Drawing No. A/DMC/05) certified as to its accuracy by the Authorized Person and annexed hereto;
- “Deed”** means this Deed as amended or varied from time to time;
- “Disabled Car Parking Spaces”** means the 4 parking spaces at the Lower Ground 2 Floor in the Phase II Car Park provided and designated for the parking of motor vehicles by disabled persons as defined in the Road Traffic Ordinance (Cap.374 of the Laws of Hong Kong), any regulations made thereunder and any amending legislation, and belonging to the residents of the Phase II Residential Development and their bona fide guests, visitors or invitees pursuant to Special Condition No.(57)(b)(i) of the Government Grant and as shown in car park layout plan or amended car park layout plan approved by the Director, and also as for identification purpose only shown and coloured yellow and marked “ACC” on the plan (Drawing No. A/DMC/03) certified as to its accuracy by the Authorized Person and annexed hereto and for the avoidance of doubt, the Disabled Car Parking Spaces form part of the Visitors’ Car Parking Spaces;

“Estate Common Areas in Phase II”

means the Estate Common Areas situated within Phase II which are intended for use by Owners of the Estate and not for the sole benefit of any Owner or Owners of a particular Phase including, but not limited to, driveway(s), ramp(s), owners’ committee office, parapet walls, structural walls and columns, the foundations and other structural elements of the buildings erected on the Estate serving more than one Phase and all other communal areas within the Estate not used for the sole benefit of any Owner or Owners of a particular Phase BUT excluding the Phase II Common Areas, the Phase II Residential Common Areas and the Phase II Car Park Common Areas; and the Estate Common Areas in Phase II are for identification purpose only shown and coloured orange on the plan (Drawing No. A/DMC/05) certified as to its accuracy by the Authorized Person and annexed hereto;

“Estate Common Services and Facilities in Phase II”

means the Estate Common Services and Facilities in, on or under Phase II and which serve the Estate and not for the sole benefit of any Owner or Owners of a particular Phase including, but not limited to, lightings, wires, cables, electrical installations, fire services, security system, fittings, equipment, apparatus, other ancillary facilities installed or to be installed in the Estate Common Areas in Phase II and any other installations, systems, plant, services and facilities used or installed in or for the benefit of the Estate as part of the amenities thereof and not for the sole benefit of any Owner or Owners of a particular Phase BUT excluding anything contained in the Phase II Common Services and Facilities, the Phase II Residential Common Services and Facilities and the Phase II Car Park Common Services and Facilities;

“EV Facilities for Visitors’ Car Parking Spaces”

means all such facilities installed or to be installed within the Phase II Car Park for the purpose of or in relation to the charging of electric motor vehicles licensed under the Road Traffic Ordinance (Cap.374 of the Laws of Hong Kong), any regulations made thereunder and any amending legislation, and parking at the Visitors’ Car Parking Spaces and such facilities shall include, but not limited to, such wires, cables, ducts, trunking, electric meters, base box, socket outlets, locks, covers and other security and/or protective devices, charging station, payment device, equipment, apparatus and such other electrical or other installations or otherwise for or in relation to such purpose;

“Fire Safety Management Plan”

means the fire safety management plan and measures relating to the Phase II Residential Units with open kitchen design required to be implemented by the Buildings Department and the Fire Services Department and any addition or variation thereto from time to time in accordance with the then relevant requirements of the Buildings Department, the Fire Services Department and any other relevant Government authority;

“First Assigned Premises”

means Flat [] on the [] Floor of Tower [] [and Car/Motor Cycle Parking Space No.[] on [] Floor] of Phase [IIA/IIB] of the Estate;

“Management Units”

means the Management Units attributable to the Phase II Car Parking Spaces and the Phase II Residential Units as set out in Part II of the First Schedule hereto;

“Non-Common EV Facilities”

means all such facilities installed or to be installed within the Phase II Car Park for serving any of the Phase II Car Parking Spaces exclusively and belonging to any of the Owners of the Phase II Car Parking Spaces for the purpose of or in relation to the charging of electric motor vehicles or electric motor cycles licensed under the Road Traffic Ordinance (Cap.374 of the Laws of Hong Kong), any regulations made thereunder and any amending legislation, and parking at such Phase II Car Parking Spaces; such facilities shall include, but not limited to, such wires, cables, ducts, trunking, electric meters, base box, socket outlets, locks, covers, boiler plate and such other security and/or protective devices, equipment, apparatus and such other electrical or other installations or otherwise for or in relation to such purpose;

“Phase II”	means that part of the Estate constructed or to be constructed on part of Site A which consists of (i) “Phase IIA” (which is shown as “Phase 1” on the phasing plans approved by the Building Authority and for identification purpose only is shown and demarcated in cross-hatched pink on the phasing plans annexed hereto) comprising the Phase II Residential Units in Tower 1, Tower 2 and Tower 3, the Phase II Car Parking Spaces, the Phase II Recreational Areas and Facilities and part of the Common Areas and Common Services and Facilities in Phase II and (ii) “Phase IIB” (which is shown as “Phase 2” on the phasing plans approved by the Building Authority and for identification purpose only is shown and demarcated in cross-hatched green on the phasing plans annexed hereto) comprising the Phase II Residential Units in Tower 5(5A & 5B) and Tower 6(6A & 6B) and part of the Common Areas and Common Services and Facilities in Phase II;
“Phase II Approved Plans”	means the Approved Plans for Phase II or insofar as Phase II is concerned;
“Phase II Balcony”	means each of the Balconies forming part of a Phase II Residential Unit specified in the Sixth Schedule hereto and for identification purpose only as shown and marked “BAL” on the plans certified as to their accuracy by the Authorized Person and annexed hereto;
“Phase II Car Park”	means the Phase II Car Parking Spaces, the Visitors’ Car Parking Spaces and the Phase II Car Park Common Areas;
“Phase II Car Park Common Areas”	means the whole of the Phase II Car Park (except the Phase II Car Parking Spaces and the Visitors’ Car Parking Spaces), intended for the common use and benefit of the Owners, occupiers and licensees of the Phase II Car Parking Spaces and the occupiers and licensees of the Visitors’ Car Parking Spaces (forming part of the Phase II Residential Common Areas) including, but not limited to, the Phase II Works and Installations (excluding the Slopes and Retaining Walls in Phase II and except those forming parts of the Phase II Residential Units, the Phase II Car Parking Spaces, the Phase II Car Park Common Services and Facilities, the Phase II Residential Common Areas, the Phase II Residential Common Services and Facilities, the Phase II Common Areas, the Phase II Common Services and Facilities, the Estate Common Areas in Phase II and the Estate Common Services and Facilities in Phase II), driveways, lift lobbies, fireman’s lobbies, extra low voltage rooms, electric vehicle charger rooms, staircases and lobbies, exhaust air fan rooms, ramps, voids, pipe ducts, air ducts, hose reels, inaccessible void(s), and all other common parts specified in Schedule 1 to the Ordinance (if any) within the Phase II Car Park for the common use and benefit of the Owners, occupiers and licensees of the Phase II Car Parking Spaces and the occupiers and licensees of the Visitors’ Car Parking Spaces (forming part of the Phase II Residential Common Areas) BUT excluding the Estate Common Areas in Phase II, the Phase II Common Areas and the Phase II Residential Common Areas; and the Phase II Car Park Common Areas are for identification purpose only as shown and coloured green on the plans certified as to their accuracy by the Authorized Person and annexed hereto;
“Phase II Car Park Common Services and Facilities”	means those services and facilities in, on or under Phase II and which serve the Phase II Car Parking Spaces and the Visitors’ Car Parking Spaces including, but not limited to, the Phase II Works and Installations (excluding the Slopes and Retaining Walls in Phase II and except those forming parts of the Phase II Residential Units, the Phase II Car Parking Spaces, the Phase II Car Park Common Areas, the Phase II Residential Common Areas, the Phase II Residential Common Services and Facilities, the Phase II Common Areas, the Phase II Common Services and Facilities, the Estate Common Areas in Phase II and the Estate Common Services and Facilities in Phase II), the Common EV Facilities, plant and machinery, electrical installations fittings and equipment, barriers BUT excluding anything contained in the Estate Common Services and

Facilities in Phase II, the Phase II Common Services and Facilities and the Phase II Residential Common Services and Facilities;

“Phase II Car Parking Space”

means any Car Parking Space at the Lower Ground 2 Floor or the Lower Ground 1 Floor in the Phase II Car Park designated for the parking of motor vehicles or motor cycles (as the case may be) licensed under the Road Traffic Ordinance (Cap.374 of the Laws of Hong Kong), any regulations made thereunder and any amending legislation, and belonging to the residents of the Residential Development or their bona fide guests, visitors or invitees in accordance with the Phase II Approved Plans and Special Condition Nos.(57)(a)(i) and (57)(c)(i) of the Government Grant, and as shown in the car park layout plan or amended car park layout plan approved by the Director, and for the avoidance of doubt, includes the Non-Common EV Facilities exclusively serving such Car Parking Space;

“Phase II Common Areas”

means those parts of Phase II which are intended for use by the Owners of more than one constituent parts of Phase II, namely the Phase II Car Park and the Phase II Residential Development and not for the sole benefit of the Owners of only one constituent part including, but not limited to, the Phase II Works and Installations (including part of the Slopes and Retaining Walls in Phase II but except those forming parts of the Phase II Residential Units, the Phase II Car Parking Spaces, the Phase II Car Park Common Areas, the Phase II Car Park Common Services and Facilities, the Phase II Residential Common Areas, the Phase II Residential Common Services and Facilities, the Phase II Common Services and Facilities, the Estate Common Areas in Phase II and the Estate Common Services and Facilities in Phase II), smoke lobby, accessible toilet, water meter cabinets, refuse storage and material recovery chamber, guard house, estate office, security management office, quarters for watchmen and caretakers lavatories, staircases and lobbies, CLP delivery hatch rooms, electrical rooms, extra low voltage rooms, upper part of extra low voltage room, emergency generator rooms, fan rooms, exhaust air fan room, fireman’s lobbies, fire control centre, fire services pump room, fire services and sprinkler pump room, upper part of fire services and sprinkler pump room, fire services pipe duct, hose reels, low voltage switch rooms, master meter room, mobile phone operator room, sprinkler control valves room, street hydrant pump room, upper part of street hydrant pump room, pump rooms, transformer rooms, switch room, air ducts, pipe ducts, exhaust air duct, and all other common parts specified in Schedule 1 to the Ordinance (if any) within Phase II not used for the sole benefit of the Owners of any one constituent part of Phase II only BUT excluding the Estate Common Areas in Phase II, the Phase II Residential Common Areas and the Phase II Car Park Common Areas and for identification purpose only as shown and coloured indigo on the plans certified as to their accuracy by the Authorized Person and annexed hereto;

“Phase II Common Services and Facilities”

means those services and facilities constructed or to be constructed in, on or under the Phase II and which serve more than one constituent parts of Phase II, namely the Phase II Car Park and the Phase II Residential Development including, but not limited to, the Phase II Works and Installations (including part of the Slopes and Retaining Walls in Phase II but except those forming parts of the Phase II Residential Units, the Phase II Car Parking Spaces, the Phase II Car Park Common Areas, the Phase II Car Park Common Services and Facilities, the Phase II Residential Common Areas, the Phase II Residential Common Services and Facilities, the Phase II Common Areas, the Estate Common Areas in Phase II and the Estate Common Services and Facilities in Phase II), sewers, gutters, drains, water features, wells, pipes and ducts; pumps, tanks and sanitary fittings; wires, cables, electrical installations, associated facilities for provision of electricity services to Phase II, fittings, equipment and apparatus; communal aerial, cable reception, distribution and associated equipment; fire protection and fire-fighting systems, equipment and apparatus; security systems, equipment and apparatus; refuse disposal equipment and lifts; air-conditioners and fans; architectural features and any other installations, systems, plant, equipment, apparatus, fittings, services and facilities used or installed in or for

the benefit of Phase II as part of the amenities thereof and not for the sole benefit of any one constituent part of Phase II only BUT excluding anything contained in the Estate Common Services and Facilities in Phase II, the Phase II Residential Common Services and Facilities and the Phase II Car Park Common Services and Facilities;

“Phase II Greenery Area”

means the Greenery Area in Phase II including the vertical greenery areas (as for identification purpose only shown and delineated by green dashed lines and marked “GW” on the plans certified as to their accuracy by the Authorized Person and annexed hereto); and the Phase II Greenery Area is for identification purpose only as shown and coloured yellow cross-stippled black on the plans certified as to their accuracy by the Authorized Person and annexed hereto;

“Phase II House Rules”

means the house rules set out in the Fourth Schedule hereto as varied or modified by the Manager from time to time in accordance with Clause 2 of Section G of this Deed;

“Phase II Owners Sub-Committee”

means the Owners’ Sub-Committee of Phase II established in accordance with the provisions of Section F of this Deed;

“Phase II Recreational Areas and Facilities”

means the indoor pool, male changing room, female changing room, baby care room, children’s play room, lounge, function rooms, multi-function room, gym, music rooms, games rooms, recording studio, male lavatory, female lavatory, lavatories, lift lobbies, accessible toilets, sports hall, clubhouse management office, store, hose reels, air-conditioning plant rooms, filtration plant room, low voltage switch room, primary air unit room, telecommunications and broadcasting equipment room, and any other recreational facilities erected within Phase II pursuant to the provisions of Special Condition No.(45)(a) of the Government Grant which now are or may at any time during the Term be provided only for the benefit of the residents of the Phase II Residential Development and their bona fide visitors and shall not be used for any other purpose or by any other person without the prior consent of the Building Authority; such Phase II Recreational Areas and Facilities shall form part of the Private Recreational Facilities; and the Phase II Recreational Areas and Facilities are for identification purpose only as shown and delineated by blue broken lines on the plans certified as to their accuracy by the Authorized Person and annexed hereto;

“Phase II Residential Common Areas”

means those parts of the Phase II Residential Development intended for the common use and benefit of the Owners, occupiers and licensees of the Phase II Residential Development including, but not limited to, the Void, the external walls of the Ground Floor and above of the buildings erected on Phase II and architectural features thereon (including non-structural prefabricated external walls (as for identification purpose only shown and delineated by light blue broken lines on the plans certified as to their accuracy by the Authorized Person and annexed hereto) and curtain walls (as for identification purpose only shown and delineated by red broken lines on the plans certified as to their accuracy by the Authorized Person and annexed hereto) or any part thereof (including the window frames, glass barriers, glass panels, hinges, locks, handles, cast-in anchors, gasket, window sealant and such other components of the curtain walls, the non-openable windows therein or thereto and window frames, glass panels, cast-in anchors, gasket, window sealant and such other components of such non-openable windows but excluding all openable windows installed in or to any curtain wall enclosing a Phase II Residential Unit and the frames enclosing the glass panels of such openable windows, glass barriers, glass panels, hinges, locks, handles, cast-in anchors, gasket, window sealant and such other components of such openable windows)), the Phase II Works and Installations (excluding the Slopes and Retaining Walls in Phase II and except those forming parts of the Phase II Residential Units, the Phase II Car Parking Spaces, the Phase II Car Park Common Areas, the Phase II Car Park Common Services and Facilities, the Phase II Residential Common Services and Facilities, the Phase II Common Areas, the Phase II Common Services and Facilities, the Estate

Common Areas in Phase II and the Estate Common Services and Facilities in Phase II), the Phase II Greenery Area, the Visitors' Car Parking Spaces, loading and unloading bays on Ground Floor, the Phase II Recreational Areas and Facilities, the Covered Walkway, the Pedestrian Link provided in Phase II (as for identification purpose only shown and delineated by violet dashed lines on the plans certified as to their accuracy by the Authorized Person and annexed hereto), wider common corridors (as for identification purpose only shown and coloured yellow hexagon black on the plans certified as to their accuracy by the Authorized Person and annexed hereto), emergency vehicular access / driveways, integrated entrance, upper part of integrated entrance, outdoor pool, kid's pool, lift lobbies, shuttle lift lobbies, fireman's lobbies, protected lobbies to required staircases, staircases and lobbies, air-conditioning plant rooms, air-conditioner plinths, cleansing booster pump rooms, electrical rooms, extra low voltage rooms, emergency generator rooms, electric vehicle charger room, fan rooms, upper part of fan room, flushing booster pump rooms, upper part of flushing booster pump room, fire services pump room, fire services and sprinkler pump room, gas lead-in room, hose reels, lift machine rooms, maintenance platform, make up air fan room (integrated entrance), upper part of make up air fan room (integrated entrance), potable booster pump rooms, upper part of potable booster pump room, potable and flushing water pump room, sump pit pump room, smoke extraction fan rooms, upper part of smoke extraction fan room, sprinkler pump rooms, upper part of sprinkler pump room, telecommunications and broadcasting equipment rooms, water meter cabinets, areas within Phase II for installation or use of communal aerial broadcast network or telecommunications network facilities, refuse storage and material recovery rooms, open yard, common flat roofs, flat roofs, roof(s), top roofs, upper roofs, air ducts, exhaust air ducts, fire services ducts, extra low voltage ducts, pipe ducts, pipe duct room, all structural columns (if any) within or appertaining to any Phase II Residential Unit, and all other common parts specified in Schedule 1 to the Ordinance (if any) within the Phase II Residential Development for the common use and benefit of the Owners, occupiers and licensees of the Phase II Residential Development BUT excluding the Estate Common Areas in Phase II, the Phase II Common Areas and the Phase II Car Park Common Areas; and the Phase II Residential Common Areas are for identification purpose only as shown and coloured yellow, yellow hexagon black and yellow cross-stippled black, delineated by green dashed lines and marked "GW", and delineated by black broken lines, violet dashed lines, red broken lines, light blue broken lines and blue broken lines on the plans certified as to their accuracy by the Authorized Person and annexed hereto;

"Phase II Residential Common Services and Facilities"

means those services and facilities in, on or under Phase II intended for the common use and benefit of the Owners, occupiers and licensees of the Phase II Residential Development including, but not limited to, the Phase II Works and Installations (excluding the Slopes and Retaining Walls in Phase II and except those forming parts of the Phase II Residential Units, the Phase II Car Parking Spaces, the Phase II Car Park Common Areas, the Phase II Car Park Common Services and Facilities, the Phase II Residential Common Areas, the Phase II Common Areas, the Phase II Common Services and Facilities, the Estate Common Areas in Phase II and the Estate Common Services and Facilities in Phase II), the EV Facilities for Visitors' Car Parking Spaces, gondola and lifting platforms, emergency lighting system, ducting, pipes, cables, wiring, water pumps, water tanks, plant and machinery, electrical installations, fittings, equipment and apparatus, and lifts BUT excluding anything contained in the Estate Common Services and Facilities in Phase II, the Phase II Common Services and Facilities and the Phase II Car Park Common Services and Facilities;

"Phase II Residential Development"

means that part of the Residential Development comprising five Towers as indicated on the Phase II Approved Plans for residential use;

"Phase II Residential Unit"

means a Unit including any Phase II Balcony, Phase II Utility Platform, air-conditioning platform (as for identification purpose only shown and marked

double hatched black and “AREA FOR AIR-CONDITIONER (AIR-CONDITIONING PLATFORM)” on the plans certified as to their accuracy by the Authorized Person and annexed hereto), roof (including any glass balustrades enclosing the roof), flat roof (including any glass balustrades enclosing the flat roof) and/or stairhood appertaining thereto (if any) situated in the Phase II Residential Development; for the avoidance of doubt it is expressly provided and declared that a Phase II Residential Unit shall include (i) all openable windows installed in or to any curtain wall enclosing the Phase II Residential Unit and the frames enclosing the glass panels of such openable windows, glass barriers, glass panels, hinges, locks, handles, cast-in anchors, gasket, window sealant and such other components of such openable windows, (ii) windows (whether openable or not) installed in or to any external walls (other than curtain walls) enclosing the Phase II Residential Unit and the window frames on the external walls, frames enclosing the glass panels of such windows, glass barriers, glass panels, hinges, locks, handles, cast-in anchors, gasket, window sealant and such other components of such windows, (iii) the plaster and covering of the internal surface of the external walls enclosing such Phase II Residential Unit and the plaster and covering of the internal surface of other enclosing walls abutting on the Phase II Residential Common Areas enclosing such Phase II Residential Unit (but not any other part of those walls), (iv) all non-structural or non-load bearing internal partitions and walls of such Phase II Residential Unit (but in case of a non-structural Party Wall adjoining two Phase II Residential Units only up to the mid point of such Party Wall), (v) any fire fighting and protection installations including but not limited to full-height fire rated resistant wall, smoke detector, fire alarm, sprinkler systems, sprinkler heads, automatic fire detection devices serving such Phase II Residential Unit with open kitchen design exclusively and (vi) any Noise Mitigation Measures in Phase II (more particularly described in Clause 10 of Section D of this Deed) serving such Phase II Residential Unit exclusively but shall exclude all structural columns (if any) within or appertaining to the Phase II Residential Unit;

“Phase II Utility Platform”

means each of the Utility Platforms forming part of a Phase II Residential Unit specified in the Sixth Schedule hereto and for identification purpose only as shown and marked “U.P.” on the plans certified as to their accuracy by the Authorized Person and annexed hereto;

“Phase II Works and Installations”

means all the Works and Installations in Phase II requiring regular maintenance on a recurrent basis including, but not limited to, those works and installations as set out in the Fifth Schedule hereto;

“Principal Deed”

means the Principal Deed of Mutual Covenant and Management Agreement dated [*] and registered in the Land Registry by Memorial No.[*] affecting the Land;

“Tower”

means any of the five residential tower blocks, namely, Tower 1, Tower 2, Tower 3, Tower 5(5A & 5B) and Tower 6(6A & 6B), constructed as part of the Phase II Residential Development and “Towers” shall be construed accordingly;

“Visitors’ Car Parking Spaces”

means 25 parking spaces on the Lower Ground 2 Floor in the Phase II Car Park provided and designated for parking of motor vehicles licensed under the Road Traffic Ordinance (Cap.374 of the Laws of Hong Kong), any regulations made thereunder and any amending legislation, and belonging to the bona fide guests, visitors or invitees of the residents of the Phase II Residential Development pursuant to Special Condition No.(57)(a)(iii) of the Government Grant and as shown in the car park layout plan or amended car park layout plan approved by the Director, and also for identification purpose only as shown and coloured yellow and marked “V” on the plan (Drawing No. A/DMC/03) certified as to its accuracy by the Authorized Person and annexed hereto and include the Disabled Car Parking Spaces; and

“Void”

means all the voids forming part of the Phase II Residential Common Areas and located above the Station.

SECTION C

RIGHTS OF OWNERS

Rights attaching to each Share

1. Each Share allocated to Phase II of the Estate shall during the residue of the Term and any renewal thereof subject to the covenants and terms contained in the Government Grant, the Principal Deed and this Deed be held by the person or persons from time to time entitled thereto together with :-

- (a) the full and exclusive right and privilege to hold, use and occupy the Unit designated opposite to it in Part I of the First Schedule hereto; and
- (b) the benefit, insofar as applicable, of the easements, rights and privileges set out in Part I of the Second Schedule hereto,

but subject to the exceptions and reservations set out in Part II of the Second Schedule hereto.

Rights of MTR

2. MTR shall during the residue of the Term and any renewal thereof subject to the covenants and terms contained in the Government Grant, the Principal Deed and this Deed have the full and exclusive right and privilege to hold, use, occupy and enjoy the whole of Phase II together with the appurtenances thereto save and except the First Assigned Premises.

Rights of Purchaser

3. The Purchaser shall during the residue of the Term and any renewal thereof subject to the covenants and terms contained in the Government Grant, the Principal Deed and this Deed have the full and exclusive right and privilege to hold, use, occupy and enjoy the First Assigned Premises together with the appurtenances thereto.

Disposal restrictions

4. (a) The right to the exclusive use, occupation and enjoyment of any Phase II Residential Unit or Phase II Car Parking Space or any part thereof shall not be sold, assigned, mortgaged, charged, leased (other than for a term of less than 10 years), licensed or otherwise disposed of separately from the Share with which the same is held.

(b) The Phase II Car Parking Spaces shall not be used for any purpose other than for the purposes of parking of motor vehicles or motor cycles (as the case may be) licensed under the Road Traffic Ordinance (Cap.374 of the Laws of Hong Kong), any regulations made thereunder and any amending legislation, and belonging to the residents of the Residential Development or their bona fide guests, visitors or invitees in accordance with the Phase II Approved Plans and the Government Grant and in particular the Phase II Car Parking Spaces shall not be used for the storage, display or exhibiting of motor vehicles for sale or otherwise or for the provision of car cleaning and beauty services.

SECTION D

OBLIGATIONS OF OWNERS AND POWERS OF MANAGER

Owners and Manager to comply

1. (a) The Owners of Units in Phase II (including MTR) and the Manager shall at all times hereafter so long as they remain as Owners of any Shares in Phase II or the Manager (as the case may be) comply with and shall observe and perform the covenants, provisions, restrictions and prohibitions contained in :-

- (i) the Government Grant;
- (ii) the Principal Deed;
- (iii) this Deed; and
- (iv) the SCL Portion Assignment.

Liability of Manager

(b) The Manager, when exercising his right to enter on, into or upon any Unit in Phase II in accordance with Clause 1(b)(xxxiii) of Section I of the Principal Deed and Clause 2(a) of Part II of the Second Schedule to the Principal Deed, shall repair at his own costs and expense any damage so caused and shall be liable for the negligent, wilful or criminal acts of the Manager, his staff, agents and contractors.

Owners not to indemnify the Manager

(c) Nothing contained in the Principal Deed and this Deed shall exclude the liability of the Manager to the Owners of Units in Phase II for any act or omission involving criminal liability, dishonesty or negligence on the part of the Manager or his staff, agents or contractors and no Owner of a Unit in Phase II shall be required to indemnify the Manager or his staff, agents or contractors from and against any actions, claims, etc. arising out of any such act or omission.

Owners to observe restrictive covenants

2. The Owners of a Unit in the Phase II Residential Development and the Phase II Car Park shall at all times hereafter be bound by and shall observe and perform the covenants, restrictions and prohibitions set out in the Third Schedule hereto insofar as the same are applicable to them.

Management Charges

3. (a) Each Owner of a Unit in Phase II shall upon demand pay to the Manager the Management Charges in respect of any Unit owned by him, calculated in accordance with the provisions of Section J of the Principal Deed.

(b) For the avoidance of doubt, the construction costs of uncompleted parts of Phase II as at the date of this Deed and the management and maintenance expenses in relation to the Common Areas and the Common Services and Facilities in Phase IIB before MTR assigns any Unit in Phase IIB pursuant to consent to assign to be issued by the Director for Phase IIB shall be borne by MTR solely so that the Owners of Units in the completed parts of Phase II with consent to assign issued by the Director therefor shall not be liable for the payment of any construction costs of uncompleted parts of Phase II and any management and maintenance expenses in relation to the Common Areas and the Common Services and Facilities in Phase IIB before MTR assigns any Unit in Phase IIB pursuant to consent to assign to be issued by the Director for Phase IIB.

Assignment of Common Areas and Common Services and Facilities

4. (a) MTR shall upon execution of this Deed assign the Shares in those parts of the Common Areas and Common Services and Facilities in Phase IIA together with the said Common Areas and Common Services and Facilities in Phase IIA to the Manager free of costs or consideration to be held by the Manager as trustee for all the Owners and the Manager must assign the said Shares together with the said Common Areas and Common Services and Facilities free of costs or consideration to his successors as manager on

termination of his appointment or to the Owners' Corporation at any time if so required by the Owners' Corporation.

(b) After completion of Phase IIB (as evidenced by the issue of the consent to assign by the Director for Phase IIB) and upon assignment of any Unit in Phase IIB by MTR, MTR shall assign the Shares (if any) in those parts of the Common Areas and Common Services and Facilities in Phase IIB together with the said Common Areas and Common Services and Facilities in Phase IIB to the Manager free of costs or consideration to be held by the Manager as trustee for all the Owners and the Manager must assign the said Shares (if any) together with the said Common Areas and Common Services and Facilities free of costs or consideration to his successors as manager on termination of his appointment or to the Owners' Corporation at any time if so required by the Owners' Corporation.

**Phase II Residential
Units with open kitchen**

5. (a) Each Owner of the Phase II Residential Units with open kitchen shall in such manner at his sole expense repair maintain and keep in good repair and condition the fire fighting and protection installations in or appertaining to his Phase II Residential Unit including, but not limited to, full-height fire rated resistant wall, smoke detector(s), fire alarm(s) and sprinkler head(s) and when necessary replace any part or parts thereof which require replacement to the satisfaction of the relevant Government department(s). The Owner and resident of any Phase II Residential Unit with open kitchen shall comply with the following fire safety provisions to the satisfaction of the relevant Government department(s) and the Manager :-

- (i) addressable smoke detectors provided at the common lobby outside the Phase II Residential Units shall not be removed or tampered or obstructed;
- (ii) addressable smoke detectors provided inside the Phase II Residential Units shall not be removed or tampered or obstructed;
- (iii) sprinkler head provided at the ceiling immediately above the open kitchen shall not be removed or tampered or obstructed;
- (iv) the full height wall having a fire resistance rating of not less than -/30/30 adjacent to the exit door of the Phase II Residential Unit shall not be removed or tampered;
- (v) the fire safety provisions mentioned in sub-sub-clauses (i), (ii) and (iii) above shall be subject to annual check and maintenance and inspection work at the cost and expense of the Owners of the Phase II Residential Units with open kitchen conducted by the fire service installation contractor registered with the Fire Services Department appointed by the Manager ("RFSIC") and the RFSIC shall be responsible for issuance of the relevant maintenance certificate (F.S.251) to prove that such maintenance and inspection work have been carried out and such maintenance certificate shall be submitted to the Fire Services Department with a copy thereof to be filed with the Manager; and
- (vi) the Owners and residents of the Phase II Residential Units shall allow access for the RFSIC to carry out annual check, maintenance and inspection of the fire safety provisions mentioned in sub-sub-clauses (i), (ii) and (iii) above in the Phase II Residential Units.

(b) The Owner or residents of any Phase II Residential Unit with open kitchen shall at his own costs and expenses observe and comply with the Fire Safety Management Plan and the fire safety provisions mentioned in this Clause and any guideline or direction to be issued or given by the Manager from time to time relating to the implementation of the Fire Safety Management Plan and shall ensure his tenants and other occupiers of his Phase II Residential Unit observe and comply with the same. The Manager shall assist the Owners, tenants and occupiers of the Phase II Residential Units with open kitchen to, inter alia, carry out annual maintenance and inspection of the fire services installation and submit the relevant maintenance certificates (F.S. 251) to Fire Services Department.

(c) The Manager shall have the power to implement and/or monitor proper implementation of the Fire Safety Management Plan (including, but not limited to, providing staff training including the course of actions to be carried out by the security officer/security guard, carrying out fire drill annually and affixing permanent notice at the Phase II Residential Common Areas (such as in lift lobbies and on notice board) to remind the residents not to remove or demolish any fire safety provision) by the Owners whose Phase II Residential Units contain approved open kitchen design in accordance with the Fire Safety Management Plan and on reasonable notice (except in an emergency), to enter into the relevant Phase II Residential Units for the purposes of carrying out maintenance to the Estate or abating any hazard or nuisance which does or may affect the Common Areas or other Owners caused by any breach by any Owners in respect of the Fire Safety Management Plan in the Phase II Residential Units PROVIDED THAT the Manager shall at his own costs and expenses repair any damage caused by such entry (excluding any damage caused by such breach by any such Owners as aforesaid, the costs and expenses of repairing the same shall be borne by the defaulting Owners) and be liable for any act or omission involving criminal liability, dishonesty or negligence by or on the part of the Manager, his staff, agents and contractors. All costs and expenses incurred by the Manager in connection with the implementation and/or monitoring of the Fire Safety Management Plan shall be borne by the Owner(s) of the relevant Phase II Residential Unit(s) with open kitchen.

(d) Within one month after the date of this Deed, MTR shall deposit a full copy of the Fire Safety Management Plan in the security management office in Phase II for inspection by all Owners of Phase II free of charge and taking copies upon payment of a reasonable charge. All charges received shall be credited to the relevant account of the Special Fund for Phase II.

(e) Each Owner of the Phase II Residential Unit with open kitchen shall at his own costs and expenses indemnify the Owners or occupiers of the other Units for his failure to observe or comply with the provisions of this Clause.

Ownership and maintenance of Non-Common EV Facilities

6. (a) Each Owner of the Phase II Car Parking Space shall at his own cost and expense be responsible for the operation, maintenance, inspection, security, repair, replacement and renewal of the Non-Common EV Facilities serving his Phase II Car Parking Space exclusively and the ownership of all such facilities shall belong to him. Each Owner of the Phase II Car Parking Space shall indemnify the Owners or occupiers of other Units for his failure to observe and comply with the provisions of this Clause.

(b) Without prejudice to the generality of sub-clause (a) above, if any Owner of the Phase II Car Parking Space shall fail to repair, maintain, replace or renew the Non-Common EV Facilities serving his Phase II Car Parking Space exclusively in accordance with sub-clause (a) above and it has caused damage or, in the reasonable opinion of the Manager, danger to the other part of Phase II or the Owners or occupiers of the other Units, the Manager shall have the right and power, but not obliged, to carry out such repairs,

maintenance, replacement or renewal works to the relevant Non-Common EV Facilities and make good all damage (if any) caused by the Owner's failure to repair, maintain, replace or renew as the Manager shall in his absolute discretion see fit and all the costs and expenses incurred by the Manager in connection therewith shall be recoverable from the Owner of the relevant Phase II Car Parking Space as a debt.

(c) The appearance and standards of all replaced Non-Common EV Facilities installed by an Owner of the Phase II Car Parking Space shall be consistent and compatible with the appearance and standards of the original Non-Common EV Facilities installed for his Phase II Car Parking Space.

Compliance with ordinances, etc. in respect of Non-Common EV Facilities

7. Each Owner of the Phase II Car Parking Space shall at his own costs and expense at all times :-

(a) observe and comply with all ordinances, bye-laws and Government regulations of Hong Kong and guidelines and directions as may be issued by the former Environment Bureau or the Environment and Ecology Bureau or the Electrical and Mechanical Services Department or all other Government authorities from time to time and all the Building Rules (if any) and the Phase II House Rules (if any) as may be made and all such directions (if any) as may be given by the Manager from time to time in relation to the installation, use, operation, maintenance, repair, replacement and/or renewal of the Non-Common EV Facilities or any part thereof serving his Phase II Car Parking Space exclusively including, but not limited to, any works to be carried out thereat and control of the consistent appearance of the Non-Common EV Facilities;

(b) take good care and such precautions as may be necessary in the use or operation of the Non-Common EV Facilities or any part thereof serving his Phase II Car Parking Space exclusively so as to avoid any loss, damage, nuisance or annoyance to Owners or occupiers of the other Units; and

(c) indemnify the Owners or occupiers of the other Units for his failure to observe or comply with the provisions of this Clause.

Compliance with ordinances, etc. in respect of EV Facilities for Visitors' Car Parking Spaces

8. The Owners of the Phase II Residential Units shall ensure that the bona fide guests, visitors and invitees of the residents of the Phase II Residential Units shall at all times :-

(a) observe and comply with all ordinances, bye-laws and Government regulations of Hong Kong and guidelines and directions as may be issued by the former Environment Bureau or the Environment and Ecology Bureau or the Electrical and Mechanical Services Department or any Government authorities from time to time and all the Building Rules (if any) as may be made and all such directions (if any) as may be given by the Manager from time to time in relation to the use or operation of the EV Facilities for Visitors' Car Parking Spaces;

(b) take good care and such precautions as may be necessary in the use of the EV Facilities for Visitors' Car Parking Spaces or any part thereof so as to avoid any loss, damage, nuisance or annoyance to Owners or occupiers of the other Units; and

(c) indemnify the Owners or occupiers of the other Units for their failure to observe or comply with the provisions of this Clause.

Electricity supply

9. (a) For provision of electricity services to Phase II, CLP Power Hong Kong Limited, its employees and contractors shall have the right to operate the equipment and facilities of CLP Power Hong Kong Limited installed in the transformer rooms in Phase II PROVIDED THAT the Manager shall at

all times be responsible for the management and control of the transformer rooms in Phase II.

(b) The Owners of Units in Phase II shall, at their own cost and expense acting through the Manager, be responsible for the repair and maintenance of the transformer rooms, cable accommodations and all associated facilities (excluding the equipment and facilities of CLP Power Hong Kong Limited) for provision of electricity services to Phase II and be responsible for any reinstatement work to the transformer rooms and cable accommodations rendered necessary by the installation, repair or replacement of the equipment and facilities of CLP Power Hong Kong Limited therein.

Maintenance of Noise Mitigation Measures in Phase II

10. All the Owners of the Phase II Residential Units which contain the Noise Mitigation Measures serving or belonging to such Residential Units exclusively shall observe and comply with all the ordinances, by-laws and Government regulations of Hong Kong and guidelines and directions as may be issued by any Government authorities from time to time in relation to use or maintenance or operation of the Noise Mitigation Measures in Phase II (namely, acoustic windows (baffle-type), acoustic balconies (baffle-type), acoustic doors (baffle-type) and fixed glazing with/without maintenance windows as for identification purpose only respectively shown and delineated by green dashed lines with dots, orange dashed lines hatched orange, violet dashed lines with double dots and indigo dashed lines on the plans (Drawing Nos. A/DMC/24 to A/DMC/33) certified as to their accuracy by the Authorized Person and annexed hereto) and no Owner of such Phase II Residential Unit shall do or permit any act or thing to be done which may in any way damage or affect the Noise Mitigation Measures in Phase II.

Curtain walls and windows

11. The Owner of any Phase II Residential Unit shall be responsible for the cleaning of the internal surface of the curtain walls (including the openable windows and/or the non-openable windows installed therein or thereto) enclosing his Phase II Residential Unit. The Owner of any Phase II Residential Unit shall be responsible for the repair, maintenance and replacement works of the openable windows installed in or to any curtain wall enclosing his Phase II Residential Unit and the frames enclosing the glass panels of such openable windows, glass barriers, glass panels, hinges, locks, handles, cast-in anchors, gasket, window sealant and such other components of such openable windows and unless such works are minor in nature in the reasonable opinion of the Manager, shall only engage contractors nominated and approved by the Manager to carry out such works. The Owner of any Phase II Residential Unit shall also be responsible for the repair, maintenance and replacement of the windows (whether openable or not) belonging to his Phase II Residential Unit. The Owners of the Phase II Residential Units shall not object and shall render full cooperation to the Manager for the purpose of cleaning the external surfaces and carrying out any works with regards to the curtain walls. When the Manager carries out cleaning of the external surface of the curtain walls, the Manager shall have the right to clean the external surface of the openable windows in the curtain walls as well and the costs and expenses incurred in connection therewith shall be paid from the management fund in respect of the Phase II Residential Common Areas.

SECTION E

MEETINGS OF THE OWNERS OF PHASE II

Meetings of the Owners

1. From time to time as occasion may require there shall be meetings of the Owners of Phase II to discuss and decide matters concerning Phase II as hereinafter mentioned and in regard to such meetings the provisions of this Section shall apply. The procedure at a meeting of the Owners of Phase II shall be as is determined by the Owners of Phase II.

Annual Meeting

2. (a) The Manager shall convene a meeting of the Owners of Phase II and the first such meeting is to be convened within nine months of the date of this Deed.

(b) One such meeting, to be known as the Annual Meeting, shall be held as soon as practicable after the end of each financial year (as defined by Clause 3 of Section J of the Principal Deed) for the purposes of receiving the Manager's report and an income and expenditure account and balance sheet for the previous financial year of Phase II, and transacting any other business of which due notice is given in the notice convening the meeting.

Convening of meeting

3. A meeting of the Owners of Phase II may be convened by :-

- (a) the Phase II Owners Sub-Committee;
- (b) the Manager; or
- (c) an Owner of Phase II appointed to convene such a meeting by the Owners of Phase II of not less than 5% of the Shares attributable to Phase II in aggregate.

Notice

4. The person convening the meeting of the Owners of Phase II shall, at least 14 days before the date of the meeting, give notice of the meeting to each Owner of Phase II. The notice of meeting shall specify the date, time and place of the meeting and the resolutions (if any) that are to be proposed at the meeting. The notice of meeting may be given :-

- (a) by delivering it personally to the Owners;
- (b) by sending it by post to the Owner at his last known address; or
- (c) by leaving it at the Owner's Unit or depositing it in the letter box for that Unit,

PROVIDED THAT notice of meeting shall also be given to the Owner of the MTR Portion and/or the SCL Portion Owner by prepaid post or hand delivery to their respective registered offices or last known places of business (as the case may be) and (i) if the matter or matters to be discussed or resolved may in the reasonable opinion of the Owner of the MTR Portion affect or have an impact on the MTR Portion, the Kwun Tong Line Extension and/or be ancillary or pertaining thereto, the Owner of the MTR Portion shall be entitled to attend the meeting; and (ii) if the matter or matters to be discussed or resolved may in the reasonable opinion of the SCL Portion Owner affect or have an impact on the SCL Portion, the Shatin to Central Link and/or be ancillary or pertaining thereto, the SCL Portion Owner shall be entitled to attend the meeting.

Quorum

5. (a) No business shall be transacted at any meeting unless a quorum is present when the meeting proceeds to business.

(b) 10% of the Owners of Phase II present in person or by proxy shall be a quorum at any meeting. For the purpose of this sub-clause, the reference to "10% of the Owners of Phase II" shall be construed as a reference to 10% of the

number of persons who are Owners of Phase II without regard to their ownership of any particular percentage of the total number of Shares into which Phase II is divided and not be construed as the Owners of 10% of the Shares in Phase II in aggregate.

Chairman

6. A meeting of the Owners of Phase II shall be presided over by the chairman of the Phase II Owners Sub-Committee or if the meeting is convened under Clause 3(b) or 3(c) of this Section, the person convening the meeting.

Minutes

7. The chairman shall cause the Manager to keep a record of the persons present at the meeting and the proceedings thereof.

Voting

8. (a) At a meeting of the Owners of Phase II :-
- (i) an Owner shall have one vote in respect of each Share he owns;
 - (ii) an Owner may cast a vote personally or by proxy;
 - (iii) where 2 or more persons are the co-Owners of a Share, the vote in respect of the Share may be cast :-
 - (I) by a proxy jointly appointed by the co-Owners;
 - (II) by a person appointed by the co-Owners from amongst themselves; or
 - (III) if no appointment is made under Clauses 8(a)(iii)(I) or 8(a)(iii)(II) of this Section, either by one of the co-Owners personally or by a proxy appointed by one of the co-Owners;
 - (iv) where 2 or more persons are the co-Owners of a Share and more than one of the co-Owners seek to cast a vote in respect of the Share, only the vote that is cast, whether personally or by proxy, by the co-Owner whose name, in order of priority, stands highest in relation to that Share in the register kept at the Land Registry shall be treated as valid; and
 - (v) if there is an equality of votes the person presiding over the meeting shall have in addition to a deliberative vote, a casting vote.
- (b) An instrument appointing a proxy shall be in the form set out in Form 1 in Schedule 1A of the Ordinance, and
- (i) shall be signed by the Owner; or
 - (ii) if the Owner is a body corporate, shall, notwithstanding anything to the contrary in its constitution, be impressed with the seal or chop of the body corporate and signed by a person authorized by the body corporate in that behalf.
- (c) The instrument appointing a proxy shall be lodged with the chairman of the Phase II Owners Sub-Committee or, if the meeting is convened under Clause 3(b) or 3(c) of this Section, the person convening the meeting at least 48 hours before the time for the holding of the meeting.
- (d) A proxy appointed by an Owner to attend and vote on behalf of the Owner shall, for the purposes of the meeting, be treated as being the Owner present at the meeting.

(e) For the avoidance of doubt, there shall not be any votes attaching to Shares allocated to the Estate Common Areas in Phase II and the Estate Common Services and Facilities in Phase II, the Phase II Common Areas and the Phase II Common Services and Facilities, the Phase II Residential Common Areas and the Phase II Residential Common Services and Facilities or the Phase II Car Park Common Areas and the Phase II Car Park Common Services and Facilities nor shall such Shares carry any liability to pay any fees or charges under the Principal Deed or this Deed or be taken into account for the purpose of counting a quorum of any meeting, and the Manager shall not be entitled to vote as trustee of the relevant Owners of the Shares allocated thereto at any meeting of the Owners of Phase II.

Resolutions binding on Owners

9. (a) Any resolution on any matter concerning Phase II, save only those matters referred to in Clause 11 of this Section, passed at a duly convened meeting by a majority vote of the Owners of Phase II present in person or by proxy and voting shall be binding on all the Owners of Phase II PROVIDED THAT :-

- (i) the notice convening the meeting shall have been duly given and shall have specified the intention to propose a resolution concerning such matter;
- (ii) no resolution purporting to be passed at any such meeting concerning any matter not mentioned in such notice shall be valid;
- (iii) no resolution shall be valid to the extent that it purports to alter or amend the provisions of this Deed or is inconsistent therewith save as herein specifically provided;
- (iv) no resolution shall be valid to the extent that it is in conflict with or contrary to any order ruling or judgment of the Hong Kong courts or any mandatory provision of any statute;
- (v) any resolution on matters or issues which in the reasonable opinion of the Owner of the MTR Portion or the SCL Portion Owner may affect or have an impact on the MTR Portion, the Kwun Tong Line Extension, the SCL Portion or the Shatin to Central Link (as the case may be) and/or be ancillary or pertaining thereto, shall be subject to the agreement of the Owner of the MTR Portion or the SCL Portion Owner (as the case may be);
- (vi) no resolution shall damage, interfere with, obstruct or endanger the construction, use, operation, maintenance or safety of the Station, the Kwun Tong Line Extension or the Shatin to Central Link or any part thereof; and
- (vii) no resolution (other than a resolution pursuant to Section D of the Principal Deed) shall have any adverse effect on the use, operation or maintenance of the Government Accommodation or any part thereof or the services and facilities supplying the Government Accommodation.

(b) A resolution may be passed as to the manner in which the powers and duties conferred on the Manager by the Principal Deed or this Deed are to be exercised or carried out but no such resolution shall invalidate any prior act of the Manager which would have been valid had that resolution not been passed.

Accidental omission of notice

10. The accidental omission to give notice as aforesaid to any Owner shall not invalidate the proceedings at any meeting and any resolution passed thereat.

Resolutions requiring special majority

11. Notwithstanding the provisions of Clause 9 of this Section, no resolution in respect of the matters referred to in Section D of the Principal Deed shall be valid unless passed by the majority specified therein.

Audit of annual accounts

12. Prior to the formation of the Owners' Corporation, the Owners of Phase II at a meeting of the Owners of Phase II convened under this Deed shall have the power to require the annual accounts of Phase II to be audited by an independent auditor of their choice.

Meetings before completion of Phase IIB

13. For the avoidance of doubt, MTR as the Owner of uncompleted Units in Phase II shall not be entitled to receive notice of meeting, attend or vote at the meeting of the Owners of Phase II convened under this Deed.

SECTION F

PHASE II OWNERS SUB-COMMITTEE

Number of members

1. (a) The Phase II Owners Sub-Committee shall consist of 6 members.
- (b) The members of the Phase II Owners Sub-Committee shall be made up of :-
 - (i) 1 member from each Tower as representatives of the Phase II Residential Development; and
 - (ii) 1 member as representative of the Phase II Car Park.
- (c) For the purpose of this Section F, “each Tower” shall mean each of Tower 1, Tower 2, Tower 3, Tower 5(5A & 5B) and Tower 6(6A & 6B).

Quorum

2. (a) A quorum for meetings of the Phase II Owners Sub-Committee shall be at least 3 members.
- (b) Provided a quorum exists, the Phase II Owners Sub-Committee shall be entitled to act and continue to act notwithstanding that the number of its members falls below 6 or that for any reason less than 6 members are elected in the manner herein provided.

Eligibility for appointment

3. The following persons shall be eligible for appointment to the Phase II Owners Sub-Committee :-
 - (a) any Owner (including any one but not the other of two or more co-Owners) of a Unit in Phase II;
 - (b) the duly authorised representative PROVIDED THAT such authorisation shall be in writing addressed to the Phase II Owners Sub-Committee and may be revoked at any time on notice in writing given to the Phase II Owners Sub-Committee, in his place, of any Owner of a Unit in Phase II, being :-
 - (i) the representative of such Owner which is a body corporate; or
 - (ii) the husband, wife, or adult family member of an Owner provided such husband, wife or adult family member resides in or occupies such Owner's Unit; or
 - (c) a tenants' representative referred to in section 15 of the Ordinance.

Election of members

4. (a) The Manager shall convene a meeting of the Owners of Phase II comprising :-
 - (i) each Tower in the Phase II Residential Development; and
 - (ii) the Phase II Car Park.

The first such meeting to be convened within nine months of the date of this Deed (and to call further and subsequent meetings if required), which meeting and each subsequent Annual Meeting (as referred to in sub-clause (b) below) must appoint the members of the Phase II Owners Sub-Committee and the chairman and secretary of the Phase II Owners Sub-Committee.

(b) One such meeting, to be known as the Annual Meeting, shall be held as soon as practicable after the end of each financial year (as defined by Clause 3 of Section J of the Principal Deed) for the purposes of receiving the Manager's report and an income and expenditure account and balance sheet for the previous financial year of Phase II, and transacting any other business of which due notice is given in the notice convening the meeting.

(c) At the first meeting and at each subsequent Annual Meeting :-

- (i) the Owners of each Tower in the Phase II Residential Development shall elect 1 representative of that Tower to the Phase II Owners Sub-Committee; and
- (ii) the Owners of the Phase II Car Park shall elect 1 representative to the Phase II Owners Sub-Committee,

PROVIDED THAT no individual (whether in the capacity of an Owner or the duly authorised representative of an Owner) shall be appointed as the representative of more than one Tower in the Phase II Residential Development or as the representative of any Tower in the Phase II Residential Development and the Phase II Car Park to the Phase II Owners Sub-Committee at the same time and PROVIDED FURTHER THAT in the event that an Owner owns more than one Unit, such Owner and such Owner's duly authorised representative(s) shall not be appointed and hold office as members of the Phase II Owners Sub-Committee at the same time.

(d) The Owners of the Tower(s) in Phase IIB shall not be entitled to elect or send their representatives to the Phase II Owners Sub-Committee unless and until after the issuance of the relevant Occupation Permit(s) covering Phase IIB.

Officers

5. (a) The officers of the Phase II Owners Sub-Committee shall comprise :-

- (i) a chairman;
- (ii) a secretary; and
- (iii) such other officers (if any) as the Phase II Owners Sub-Committee may from time to time elect.

(b) All casual vacancies in the officers shall be filled by election or appointment by the members of the Phase II Owners Sub-Committee from among them as they may from time to time determine.

(c) A meeting of the Phase II Owners Sub-Committee shall be presided over by :-

- (i) the chairman; or
- (ii) in the absence of the chairman, a member of the Phase II Owners Sub-Committee appointed as chairman for that meeting.

Tenure of office

6. (a) Members of the Phase II Owners Sub-Committee shall hold office until the Annual Meeting of Owners of Phase II next following their appointment or election PROVIDED THAT if the office of the retiring members or any of them is not filled, or if in any year no Annual Meeting is held, such members or member shall continue in office until the next Annual Meeting.

(b) Retiring members of the Phase II Owners Sub-Committee shall be eligible for re-election or re-appointment as appropriate.

(c) A member of the Phase II Owners Sub-Committee shall nevertheless cease to hold office if :-

- (i) he resigns by notice in writing to the Phase II Owners Sub-Committee;
- (ii) he ceases to be eligible;
- (iii) his authority is revoked by the Owners he represents;
- (iv) he, or the Owner(s) he represents, becomes bankrupt or insolvent or is convicted of a criminal offence other than a summary offence not involving dishonesty;
- (v) he becomes incapacitated by physical or mental illness;
- (vi) he, or the Owner(s) he represents, has defaulted in paying his contribution towards the Management Charges and fails to rectify such default within 7 days from the date of warning notice in writing given by the Manager; or
- (vii) he, or the Owner(s) he represents, fails to observe and perform the provisions of the Principal Deed or this Deed and if such breach is remediable, fails to rectify such breach within such time as prescribed by the Manager in writing addressed to such Owner.

(d) Any one or more members of the Phase II Owners Sub-Committee may be removed from office by a resolution of the Owners of Units of the part of Phase II which he represents at an Extraordinary Meeting convened for the purpose by the Phase II Owners Sub-Committee, by the Manager or by Owners of Units in Phase II entitled to attend and vote at any such meeting who in the aggregate have vested in them not less than 20% of the Shares attributable to the part of Phase II which the member represents and at any such Meeting, new members of the Phase II Owners Sub-Committee may be appointed in the place of those removed from office.

Votes of members

7. Members of the Phase II Owners Sub-Committee shall be entitled to one vote each at the Phase II Owners Sub-Committee meetings and resolutions shall be passed by a simple majority of those present in person and voting. In the case of equality of voting the chairman shall have a second or casting vote.

Power to make rules

8. The Phase II Owners Sub-Committee shall have full power to determine where, when and how often it shall meet and to make rules and bye-laws regulating the conduct and procedure of its meetings and the performance of its duties and obligations PROVIDED THAT no such regulation or bye-laws shall be contrary to or inconsistent with the provisions of this Deed or the Principal Deed.

Manager to be invited

9. The Phase II Owners Sub-Committee shall invite the Manager to any meeting called by giving the Manager at least seven (7) days' notice in writing of the date, time and place of the meeting and the matters to be discussed.

Power to call meeting

10. The chairman or any two members of the Phase II Owners Sub-Committee or the Manager may at any time convene a meeting of the Phase II Owners Sub-Committee PROVIDED THAT the person or persons convening

the meeting shall, at least 7 days before the date of meeting, give to each member of the Phase II Owners Sub-Committee notice of the date, time and place of the meeting and the resolutions (if any) that are to be proposed at the meeting. The notice of a meeting may be given :-

- (a) by delivering it personally to the member;
- (b) by sending it by post to the member at his last known address;
or
- (c) by leaving the notice at the member's Unit or depositing the notice in the letter box for that Unit.

SECTION G

PHASE II HOUSE RULES

**Phase II House Rules
first in force**

1. The Phase II House Rules set out in the Fourth Schedule hereto shall be deemed to have come into force on the date of this Deed in respect of Phase II and shall remain in force until revoked or amended as hereinafter provided.

**Making and
amendment of
Phase II House Rules**

2. The Manager shall have power from time to time to make, revoke and amend the Phase II House Rules regulating the use, occupation, maintenance and environmental control (including, but not limited to, protection of the environment of Phase II and implementation of noise abatement, waste reduction and recycling measures with reference to guidelines on property management issued from time to time by the Director of Environmental Protection) of Phase II and the conduct of persons occupying, visiting or using the same and the Phase II House Rules shall not be inconsistent with or contravene the provisions of the Principal Deed, this Deed, the Ordinance or the Government Grant PROVIDED THAT if the Phase II Owners Sub-Committee is in existence, the Phase II House Rules shall only be made, revoked or amended by the Manager with the prior approval of the Phase II Owners Sub-Committee.

**Phase II House Rules to
be posted on notice
boards**

3. Copies of the Phase II House Rules from time to time in force shall be posted on the public notice boards in Phase II.

SECTION H

INTERPRETATION AND MISCELLANEOUS

- Marginal notes, headings and index**
1. The marginal notes, headings and index are intended for guidance only and do not form part of this Deed nor shall any of the provisions of this Deed be construed or interpreted by reference thereto or in any way affected or limited thereby.
- Plurals and genders**
2. In this Deed (if the context so permits or requires) words importing the singular number only shall include the plural number and vice versa, words importing the masculine gender only shall include the feminine gender and neuter gender and words importing persons shall include corporations.
- Service of notices**
3. (a) All notices or demands required to be served hereunder shall be sufficiently served if addressed to the party intended to receive the same and sent by prepaid post to or left at the Unit of which the party to be served is the Owner notwithstanding that such party shall not personally occupy such Unit PROVIDED THAT if other address has been given by an Owner pursuant to sub-clause (d) of this Clause, such notices or demands shall be sent by prepaid post to that address only and PROVIDED FURTHER THAT where notice is to be given to an Owner who is a mortgagee, such notice shall be served on the mortgagee, if a company, at its registered office or last known place of business or, if an individual at his last known residence in Hong Kong.
- (b) All notices required to be given to the Manager under this Deed shall be properly served if sent by prepaid post to or left at its registered office or the security management office in Phase II or such other address as may be notified by the Manager from time to time.
- (c) All notices required to be given to the Phase II Owners Sub-Committee shall be properly served if sent by prepaid post to or left with the chairman or secretary of the Phase II Owners Sub-Committee at his usual residential address.
- (d) All non-resident Owners shall provide the Manager with an address within Hong Kong for service of process and notices to be given pursuant to this Deed.
- Covenants to run with Land**
4. The mutual covenants herein contained are intended to be annexed to and shall run with the Land and each and every Share therein and shall be enforceable by and against the Owner for the time being of any such Share both as to the benefit and burden of such covenants, and any ordinance or other statutory enactment for the time being in force concerning the enforcement of mutual covenants relating to land or buildings shall apply to this Deed.
- Chinese translation**
5. MTR shall at its own costs and expense provide a direct translation in Chinese of this Deed and deposit a copy of this Deed and its Chinese translation at the security management office in Phase II within one month after the date of this Deed. Copies of this Deed and its Chinese translation shall be made available for inspection by all Owners of Phase II free of costs at the security management office in Phase II. A copy of this Deed or its Chinese translation or both shall be supplied by the Manager to an Owner of Phase II on request and upon payment of a reasonable charge. All charges received shall be credited to the relevant account of the Special Fund for Phase II. In the event of dispute as to the effect or construction of this Deed and its Chinese translation, the English text of this Deed shall prevail.
- The Ordinance**
6. (a) Nothing in this Deed shall prejudice or in any way be construed or constructed so as to prejudice or exclude the operation of the provisions of the Ordinance and the Schedules thereto.

Phase II Works and Installations

(b) Within one month after the date of this Deed, MTR shall at its own cost deposit a copy of Schedule 7 and Schedule 8 to the Ordinance in both English and Chinese versions in the security management office in Phase II for reference by all Owners of Phase II free of charge and for taking copies at their own expense and upon payment of reasonable copying charges. All charges received shall be credited to the relevant account of the Special Fund for Phase II.

7. (a) MTR shall compile for the reference of the Owners of Phase II and the Manager a maintenance manual for the Phase II Works and Installations (“**the Phase II Works Manual**”) setting out the following details :-

(i) as-built record plans of the building and services installations together with the necessary technical information (such as specifications of materials and design standard) for maintenance of all facilities and equipment;

(ii) all warranties and guarantees provided by contractors (together with the names of the companies providing the warranty and the contact telephone numbers) in respect of all facilities and equipment;

(iii) recommended maintenance strategy and procedures;

(iv) a list of items of the Phase II Works and Installations requiring routine maintenance;

(v) recommended frequency of routine maintenance inspection;

(vi) checklist and typical inspection record sheets for routine maintenance inspection; and

(vii) recommended maintenance cycle of the Phase II Works and Installations.

(b) MTR shall deposit a full copy of the Phase II Works Manual in the security management office in Phase II within one month after the date of this Deed for inspection by all Owners of Phase II free of charge and taking copies at their own expense and on payment of a reasonable charge which shall be credited to the relevant account of the Special Fund for Phase II.

(c) (i) The Manager shall on behalf of and at the cost and expense of the Owners of Phase II inspect, maintain and carry out all necessary works for the Common Areas and the Common Services and Facilities in Phase II including those part or parts of the Phase II Works and Installations forming part of the Common Areas and the Common Services and Facilities in Phase II.

(ii) The Owners of Phase II shall at their own cost and expense inspect, maintain and carry out all necessary works for the maintenance of Phase II and their own Units including those part or parts of the Phase II Works and Installations forming part of their Units.

(d) All costs incidental to the preparation of the schedule for the Phase II Works and Installations and the Phase II Works Manual shall be borne by MTR.

(e) The Owners of Phase II may, by a resolution of Owners at an Owners’ meeting of Phase II convened under this Deed, decide on any necessary revisions to be made to the schedule for the Phase II Works and Installations

and the Phase II Works Manual from time to time as they shall deem fit, in which event the Manager shall procure from a qualified professional or consultant the revised schedule for the Phase II Works and Installations and the revised Phase II Works Manual within such time as may be prescribed by the Owners of Phase II in an Owners' meeting of Phase II convened under this Deed. All costs incidental to the preparation of the revised schedule for the Phase II Works and Installations and the revised Phase II Works Manual shall be paid out of the relevant account of the Special Fund for Phase II.

(f) The Manager shall deposit the revised Phase II Works Manual in the security management office in Phase II within one month after the date of its preparation for inspection by all Owners of Phase II free of charge and taking copies at their own expense and on payment of a reasonable charge which shall be credited to the relevant account of the Special Fund for Phase II.

**Paragraphs 7(7) and 7(8)
of Schedule 7 to the
Ordinance**

8. (a) If any person has given an undertaking in writing to, or has entered into an agreement with, the Government to manage or be responsible for the management of the Estate, and the Owners' Corporation has appointed a Manager under Clause 2(j)(ii) of Section H of the Principal Deed, the Owners' Corporation shall be deemed to have given to that person an instrument of indemnity under which the Owners' Corporation shall be liable to indemnify that person in respect of any act or omission by the Manager appointed under Clause 2(j)(ii) of Section H of the Principal Deed that may otherwise render that person liable for a breach of that undertaking or agreement.

(b) Clauses 2(d), 2(e), 2(f), 2(g), 2(h), 2(i) and 2(j) of Section H of the Principal Deed and sub-clause (a) of this Clause are subject to any notice relating to the Estate that may be published by the Secretary for Home and Youth Affairs under section 34E(4) of the Ordinance but does not apply to any single manager referred to in that section.

THE FIRST SCHEDULE
PART I
ALLOCATION OF SHARES

Phase II Residential Units :-

		<u>No. of Shares</u>	<u>No. of Shares</u>
Tower 1	116,137		
Tower 2	114,929		
Tower 3	110,366		
Tower 5(5A)	73,516		
Tower 5(5B)	65,602		
Tower 6(6A)	74,492		
Tower 6(6B)	65,589		620,631

Phase II Car Parking Spaces :-

142 Car Parking Spaces (Nos.1001 to 1142 on Lower Ground 1 Floor) (130 Shares each)	18,460		
122 Car Parking Spaces (Nos.2001 to 2122 on Lower Ground 2 Floor) (130 Shares each)	15,860		
10 Motor Cycle Parking Spaces (Nos.M01 to M10 on Lower Ground 1 Floor) (20 Shares each)	200		34,520

Common Areas and Common Services and Facilities in Phase II :-

(i) Common Areas and Common Services and Facilities in Phase IIA (comprising parts of Phase II Common Areas and Phase II Common Services and Facilities, Phase II Car Park Common Areas and Phase II Car Park Common Services and Facilities, parts of Phase II Residential Common Areas and Phase II Residential Common Services and Facilities and Estate Common Areas in Phase II and Estate Common Services and Facilities in Phase II)			20,593
(ii) Common Areas and Common Services and Facilities in Phase IIB (comprising parts of Phase II Common Areas and Phase II Common Services and Facilities and parts of Phase II Residential Common Areas and Phase II Residential Common Services and Facilities)			14,256

Total No. of Shares : **690,000**

Allocation of Shares to each Phase II Residential Unit

<u>Tower</u>	<u>Floor</u>	<u>Flat</u>	<u>Penthouse</u>	<u>No. of Shares allocated to each Flat/Penthouse</u>	<u>Sub-Total No. of Shares</u>	
1	1/F	A*		934		
		B*		725		
		C*		928		
		D*		598		
		E*		434		
		F*		434		
		G*		592		4,645
	2/F – 15/F (11 storeys)	A@		930		
		B@		740		
		C@		930		
		D@ (2/F – 12/F)		590		
		D@ (15/F)		640		
		E@		450		
		F@		450		51,420
	16/F – 26/F (10 storeys)	A@		1,330		
		B@ (16/F – 23/F)		1,330		
		B@ (25/F & 26/F)		1,330		
		C@		1,180		
		D@		1,240		50,800
	27/F	A@*		2,325		
		B@*		2,163		4,488
	28/F		A@^	2,484		
			B@^#	2,300		4,784
						----- 116,137

Notes:

1. There are no designations of 4/F, 13/F, 14/F and 24/F of all Towers. There is no designation of Tower 4.
2. @ Flat with balcony and utility platform.
3. * Flat with flat roof.
4. ^ Flat with roof.
5. # Flat with stairhood.

<u>Tower</u>	<u>Floor</u>	<u>Flat</u>	<u>Penthouse</u>	<u>No. of Shares allocated to each Flat/Penthouse</u>	<u>Sub-Total No. of Shares</u>
2	1/F	A*		949	4,711
		B*		762	
		C*		965	
		D*		569	
		E*		445	
		F*		445	
		G*		576	
	2/F – 15/F (11 storeys)	A@		930	51,040
		B@		740	
		C@		930	
		D@		560	
		E@		460	
		F@		460	
		G@		560	
	16/F – 26/F (10 storeys)	A@ (16/F – 23/F)		1,330	49,500
		A@ (25/F)		1,330	
		A@ (26/F)		1,330	
		B@		1,330	
		C@		860	
		D@		530	
		E@		900	
	27/F	A@*		2,345	4,665
		B@		1,400	
C@			920		
28/F		A@^	2,515	5,013	
		B@^#	1,252		
		C@^#	1,246		
					----- 114,929

Notes:

1. There are no designations of 4/F, 13/F, 14/F and 24/F of all Towers. There is no designation of Tower 4.
2. @ Flat with balcony and utility platform.
3. * Flat with flat roof.
4. ^ Flat with roof.
5. # Flat with stairhood.

<u>Tower</u>	<u>Floor</u>	<u>Flat</u>	<u>Penthouse</u>	<u>No. of Shares allocated to each Flat/Penthouse</u>	<u>Sub-Total No. of Shares</u>
3	1/F	A*		962	4,563
		B*		678	
		C*		864	
		D*		601	
		E*		445	
		F*		445	
		G*		568	
	2/F – 15/F (11 storeys)	A@		920	49,440
		B@		670	
		C@		840	
		D@ (2/F – 12/F)		580	
		D@ (15/F)		630	
		E@		460	
		F@		460	
	16/F – 26/F (10 storeys)	A@ (16/F – 23/F)		920	47,200
		A@ (25/F & 26/F)		920	
		B@		670	
		C@		840	
		D@ (16/F – 25/F)		900	
		D@ (26/F)		900	
		E@		530	
	27/F	F@		860	4,443
		A@*		2,217	
		B@*		1,306	
	28/F	C@		920	4,720
		A@^		2,330	
		B@^#		1,368	
		C@^#		1,022	

					110,366

Notes:

1. There are no designations of 4/F, 13/F, 14/F and 24/F of all Towers. There is no designation of Tower 4.
2. @ Flat with balcony and utility platform.
3. * Flat with flat roof.
4. ^ Flat with roof.
5. # Flat with stairhood.

<u>Tower</u>	<u>Floor</u>	<u>Flat</u>	<u>No. of Shares allocated to each Flat</u>	<u>Sub-Total No. of Shares</u>
5(5A)	1/F	A*	709	2,940
		B*	475	
		C*	350	
		D*	480	
		E*	430	
		F*	496	
	2/F – 27/F (22 storeys)	A@	730	67,320
		B@	500	
		C@	360	
		D@	500	
		E@	450	
		F@	520	
28/F	A@^#	1,305	3,256	
	C@^	382		
	D@^	531		
	E@^	478		
	F@^	560		

				73,516

Notes:

1. There are no designations of 4/F, 13/F, 14/F and 24/F of all Towers. There is no designation of Tower 4.
2. @ Flat with balcony and utility platform.
3. * Flat with flat roof.
4. ^ Flat with roof.
5. # Flat with stairhood.

<u>Tower</u>	<u>Floor</u>	<u>Flat</u>	<u>No. of Shares allocated to each Flat</u>	<u>Sub-Total No. of Shares</u>
5(5B)	1/F	A*	683	2,619
		B*	460	
		C*	342	
		D*	330	
		E*	330	
		F*	474	
	2/F – 27/F (22 storeys)	A@	700	60,060
		B@	480	
		C@	360	
		D@	350	
		E@	350	
		F@	490	
28/F	A@^#	1,271	2,923	
	C@^	382		
	D@^	372		
	E@^	372		
	F@^	526		

				65,602

Notes:

1. There are no designations of 4/F, 13/F, 14/F and 24/F of all Towers. There is no designation of Tower 4.
2. @ Flat with balcony and utility platform.
3. * Flat with flat roof.
4. ^ Flat with roof.
5. # Flat with stairhood.

<u>Tower</u>	<u>Floor</u>	<u>Flat</u>	<u>No. of Shares allocated to each Flat</u>	<u>Sub-Total No. of Shares</u>
6(6A)	1/F	A*	695	2,973
		B*	685	
		C*	440	
		D*	337	
		E*	346	
		F*	470	
	2/F – 27/F (22 storeys)	A@	720	68,200
		B@	710	
		C@	460	
		D@	360	
		E@	360	
		F@	490	
28/F	A@^#	1,293	3,319	
	B@^	769		
	C@^	492		
	D@^	382		
	E@^	383		

				74,492

Notes:

1. There are no designations of 4/F, 13/F, 14/F and 24/F of all Towers. There is no designation of Tower 4.
2. @ Flat with balcony and utility platform.
3. * Flat with flat roof.
4. ^ Flat with roof.
5. # Flat with stairhood.

<u>Tower</u>	<u>Floor</u>	<u>Flat</u>	<u>No. of Shares allocated to each Flat</u>	<u>Sub-Total No. of Shares</u>
6(6B)	1/F	A*	683	2,609
		B*	460	
		C*	341	
		D*	330	
		E*	330	
		F*	465	
	2/F – 27/F (22 storeys)	A@	700	60,060
		B@	480	
		C@	360	
		D@	350	
		E@	350	
		F@	490	
28/F	A@^#	1,268	2,920	
	C@^	382		
	D@^	372		
	E@^	372		
	F@^	526		

				65,589

Notes:

1. There are no designations of 4/F, 13/F, 14/F and 24/F of all Towers. There is no designation of Tower 4.
2. @ Flat with balcony and utility platform.
3. * Flat with flat roof.
4. ^ Flat with roof.
5. # Flat with stairhood.

THE FIRST SCHEDULE
PART II
ALLOCATION OF MANAGEMENT UNITS

Phase II Residential Units :-

	<u>No. of Management Units</u>	<u>No. of Management Units</u>
Tower 1	116,137	
Tower 2	114,929	
Tower 3	110,366	
Tower 5(5A)	73,516	
Tower 5(5B)	65,602	
Tower 6(6A)	74,492	
Tower 6(6B)	65,589	620,631

Phase II Car Parking Spaces :-

142 Car Parking Spaces (Nos.1001 to 1142 on Lower Ground 1 Floor) (130 Shares each)	18,460	
122 Car Parking Spaces (Nos.2001 to 2122 on Lower Ground 2 Floor) (130 Shares each)	15,860	
10 Motor Cycle Parking Spaces (Nos.M01 to M10 on Lower Ground 1 Floor) (20 Shares each)	200	34,520

Common Areas and Common Services and Facilities in Phase II :-

- | | |
|---|---|
| (i) Common Areas and Common Services and Facilities in Phase IIA (comprising parts of Phase II Common Areas and Phase II Common Services and Facilities, Phase II Car Park Common Areas and Phase II Car Park Common Services and Facilities, parts of Phase II Residential Common Areas and Phase II Residential Common Services and Facilities and Estate Common Areas in Phase II and Estate Common Services and Facilities in Phase II) | 0 |
| (ii) Common Areas and Common Services and Facilities in Phase IIB (comprising parts of Phase II Common Areas and Phase II Common Services and Facilities and parts of Phase II Residential Common Areas and Phase II Residential Common Services and Facilities) | 0 |

Total No. of Management Units :	655,151
--	----------------

Allocation of Management Units to each Phase II Residential Unit

<u>Tower</u>	<u>Floor</u>	<u>Flat</u>	<u>Penthouse</u>	<u>No. of Management Units allocated to each Flat/Penthouse</u>	<u>Sub-Total No. of Management Units</u>
1	1/F	A*		934	
		B*		725	
		C*		928	
		D*		598	
		E*		434	
		F*		434	
		G*		592	4,645
	2/F – 15/F (11 storeys)	A@		930	
		B@		740	
		C@		930	
		D@ (2/F – 12/F)		590	
		D@ (15/F)		640	
		E@		450	
		F@		450	
	G@		580	51,420	
	16/F – 26/F (10 storeys)	A@		1,330	
		B@ (16/F – 23/F)		1,330	
		B@ (25/F & 26/F)		1,330	
		C@		1,180	
		D@		1,240	50,800
	27/F	A@*		2,325	
		B@*		2,163	4,488
	28/F		A@^	2,484	
			B@^#	2,300	4,784

					116,137

Notes:

1. There are no designations of 4/F, 13/F, 14/F and 24/F of all Towers. There is no designation of Tower 4.
2. @ Flat with balcony and utility platform.
3. * Flat with flat roof.
4. ^ Flat with roof.
5. # Flat with stairhood.

<u>Tower</u>	<u>Floor</u>	<u>Flat</u>	<u>Penthouse</u>	<u>No. of Management Units allocated to each Flat/Penthouse</u>	<u>Sub-Total No. of Management Units</u>
2	1/F	A*		949	4,711
		B*		762	
		C*		965	
		D*		569	
		E*		445	
		F*		445	
		G*		576	
	2/F – 15/F (11 storeys)	A@		930	51,040
		B@		740	
		C@		930	
		D@		560	
		E@		460	
		F@		460	
		G@		560	
	16/F – 26/F (10 storeys)	A@ (16/F – 23/F)		1,330	49,500
		A@ (25/F)		1,330	
		A@ (26/F)		1,330	
		B@		1,330	
		C@		860	
		D@		530	
		E@		900	
27/F	A@*		2,345	4,665	
	B@		1,400		
	C@		920		
28/F		A@^	2,515	5,013	
		B@^#	1,252		
		C@^#	1,246		
					----- 114,929

Notes:

1. There are no designations of 4/F, 13/F, 14/F and 24/F of all Towers. There is no designation of Tower 4.
2. @ Flat with balcony and utility platform.
3. * Flat with flat roof.
4. ^ Flat with roof.
5. # Flat with stairhood.

<u>Tower</u>	<u>Floor</u>	<u>Flat</u>	<u>Penthouse</u>	<u>No. of Management Units allocated to each Flat/Penthouse</u>	<u>Sub-Total No. of Management Units</u>
3	1/F	A*		962	4,563
		B*		678	
		C*		864	
		D*		601	
		E*		445	
		F*		445	
		G*		568	
	2/F – 15/F (11 storeys)	A@		920	49,440
		B@		670	
		C@		840	
		D@ (2/F – 12/F)		580	
		D@ (15/F)		630	
		E@		460	
		F@		460	
		G@		560	
	16/F – 26/F (10 storeys)	A@ (16/F – 23/F)		920	47,200
		A@ (25/F & 26/F)		920	
		B@		670	
		C@		840	
		D@ (16/F – 25/F)		900	
		D@ (26/F)		900	
		E@		530	
	F@		860		
	27/F	A@*		2,217	4,443
		B@*		1,306	
		C@		920	
	28/F		A@^	2,330	4,720
		B@^#	1,368		
		C@^#	1,022		

					110,366

Notes:

1. There are no designations of 4/F, 13/F, 14/F and 24/F of all Towers. There is no designation of Tower 4.
2. @ Flat with balcony and utility platform.
3. * Flat with flat roof.
4. ^ Flat with roof.
5. # Flat with stairhood.

<u>Tower</u>	<u>Floor</u>	<u>Flat</u>	<u>No. of Management Units allocated to each Flat</u>	<u>Sub-Total No. of Management Units</u>
5(5A)	1/F	A*	709	2,940
		B*	475	
		C*	350	
		D*	480	
		E*	430	
		F*	496	
	2/F – 27/F (22 storeys)	A@	730	67,320
		B@	500	
		C@	360	
		D@	500	
		E@	450	
		F@	520	
	28/F	A@^#	1,305	3,256
		C@^	382	
		D@^	531	
		E@^	478	
		F@^	560	

				73,516

Notes:

1. There are no designations of 4/F, 13/F, 14/F and 24/F of all Towers. There is no designation of Tower 4.
2. @ Flat with balcony and utility platform.
3. * Flat with flat roof.
4. ^ Flat with roof.
5. # Flat with stairhood.

<u>Tower</u>	<u>Floor</u>	<u>Flat</u>	<u>No. of Management Units allocated to each Flat</u>	<u>Sub-Total No. of Management Units</u>	
5(5B)	1/F	A*	683	2,619	
		B*	460		
		C*	342		
		D*	330		
		E*	330		
		F*	474		
	2/F – 27/F (22 storeys)	A@	700	60,060	
		B@	480		
		C@	360		
		D@	350		
		E@	350		
		F@	490		
	28/F	A@ ^#	1,271	2,923	
		C@ ^	382		
		D@ ^	372		
		E@ ^	372		
		F@ ^	526		

					65,602

Notes:

1. There are no designations of 4/F, 13/F, 14/F and 24/F of all Towers. There is no designation of Tower 4.
2. @ Flat with balcony and utility platform.
3. * Flat with flat roof.
4. ^ Flat with roof.
5. # Flat with stairhood.

<u>Tower</u>	<u>Floor</u>	<u>Flat</u>	<u>No. of Management Units allocated to each Flat</u>	<u>Sub-Total No. of Management Units</u>
6(6A)	1/F	A*	695	2,973
		B*	685	
		C*	440	
		D*	337	
		E*	346	
		F*	470	
	2/F – 27/F (22 storeys)	A@	720	68,200
		B@	710	
		C@	460	
		D@	360	
		E@	360	
		F@	490	
	28/F	A@^#	1,293	3,319
		B@^	769	
		C@^	492	
		D@^	382	
		E@^	383	

				74,492

Notes:

1. There are no designations of 4/F, 13/F, 14/F and 24/F of all Towers. There is no designation of Tower 4.
2. @ Flat with balcony and utility platform.
3. * Flat with flat roof.
4. ^ Flat with roof.
5. # Flat with stairhood.

<u>Tower</u>	<u>Floor</u>	<u>Flat</u>	<u>No. of Management Units allocated to each Flat</u>	<u>Sub-Total No. of Management Units</u>
6(6B)	1/F	A*	683	2,609
		B*	460	
		C*	341	
		D*	330	
		E*	330	
		F*	465	
	2/F – 27/F (22 storeys)	A@	700	60,060
		B@	480	
		C@	360	
		D@	350	
		E@	350	
		F@	490	
28/F	A@ ^#	1,268	2,920	
	C@ ^	382		
	D@ ^	372		
	E@ ^	372		
	F@ ^	526		

				65,589

Notes:

1. There are no designations of 4/F, 13/F, 14/F and 24/F of all Towers. There is no designation of Tower 4.
2. @ Flat with balcony and utility platform.
3. * Flat with flat roof.
4. ^ Flat with roof.
5. # Flat with stairhood.

THE SECOND SCHEDULE

PART I
EASEMENTS

- | | |
|--|---|
| Right to pass | <p>1. Full right and liberty for the Owner for the time being, his servants, agents, licensees, tenants and lawful occupants :-</p> <p>(a) of a Phase II Residential Unit to go, pass and repass over and along and upon the Estate Common Areas in Phase II, the Phase II Common Areas and the Phase II Residential Common Areas in common with all others having the like right; and</p> <p>(b) of a Phase II Car Parking Space to go, pass and repass over and along and upon the Estate Common Areas in Phase II, the Phase II Common Areas, the Phase II Car Park Common Areas and parts of the Phase II Residential Common Areas on Lower Ground 4 Floor, Lower Ground 3 Floor, Lower Ground 2 Floor, Lower Ground 1 Floor and Ground Floor in common with all others having the like right,</p> <p>for all purposes connected with the proper use and enjoyment of his Unit.</p> |
| Rights of Owners of the Phase II Residential Units | <p>2. Full right and liberty for the Owner for the time being, his servants, agents, licensees, tenants and lawful occupants of a Phase II Residential Unit to go, pass and repass over and along and upon the Phase II Car Park Common Areas and to use the Phase II Car Park Common Services and Facilities for all purposes connected with access and egress to and from and use of the Visitors' Car Parking Spaces.</p> |
| Rights of Owners of the Phase II Car Parking Spaces | <p>3. Subject to the provisions of Clauses 6 and 7 of Section D of this Deed and to the management expenses for the Common EV Facilities being borne by the Owners of the Phase II Car Parking Spaces, the full right and liberty (SUBJECT ALWAYS to the rights of the Manager under this Deed and the Principal Deed) for the Owner of a Phase II Car Parking Space for the time being at his own cost and expense to install, maintain, repair and replace an electric meter and such associated facilities within the electric vehicle charger rooms of the Phase II Car Park Common Areas and to lay and/or maintain, repair and replace such cables, base box, socket outlets, protective and security devices within the Phase II Car Park Common Areas at such locations and in such manner to be approved by the Manager (including, but not limited to, the designation of routing and the manner of which such installation, maintenance, repair and replacement is carried out) for the purposes of or in connection with the proper use and enjoyment and operation of the Non-Common EV Facilities serving his Phase II Car Parking Space exclusively.</p> |
| Right of way for access to and from security management office in Phase II | <p>4. The right for the Owners and occupiers of any Phase II Car Parking Space (in common with all other persons having the like right) to pass through such parts of the Phase II Residential Common Areas on the Ground Floor as may be designated or re-designated by the Manager from time to time for the purpose of access to and from the security management office in Phase II on the Ground Floor of Phase II.</p> |
| Right of way for access to and from owners' committee office | <p>5. The right for the Owners and occupiers of any Unit of the Estate (in common with all other persons having the like right) to pass through such parts of the Phase II Residential Common Areas on the Ground Floor as may be designated or re-designated by the Manager from time to time for the purpose of access to and from the owners' committee office on the Ground Floor of Phase II.</p> |

THE SECOND SCHEDULE
PART II
EXCEPTIONS AND RESERVATIONS

Rights of other
Owners

1. Easements, rights and privileges of the other Owners contained in Clauses 1, 2, 3, 4 and 5 of Part I of this Second Schedule (as the case may be) and set out in Part II of the Second Schedule to the Principal Deed insofar as the same are applicable.

Rights of Manager under
Principal Deed

2. Easements, rights and privileges of the Manager set out in Part II of the Second Schedule to the Principal Deed insofar as the same are applicable.

THE THIRD SCHEDULE
RESTRICTIONS AND PROHIBITIONS

- | | |
|---|--|
| Not to partition | 1. Not to partition any Phase II Residential Unit or Phase II Car Parking Space. |
| User | 2. (a) Not to use or permit or suffer to be used any Phase II Residential Unit for any purpose whatsoever other than as a private dwelling.

(b) Not to use or permit or suffer to be used any Phase II Car Parking Space other than for the parking of one motor vehicle or one motor cycle (as the case may be). |
| Not to make alterations or additions | 3. (a) Other than in exceptional circumstances and subject to the prior written consent of the Manager, not to make any structural alterations or additions or paint the outside of the Phase II Residential Units, alter the exterior window glass, alter or remove the railings or balustrades on any Phase II Balcony or Phase II Utility Platform, or generally do anything that might alter or affect the external appearance of the Phase II Residential Units.

(b) Not to make any structural alteration which will interfere with or affect the rights of the other Owners. |
| Phase II Balconies and Phase II Utility Platforms | 4. (a) Not to cause, permit, suffer or allow any Phase II Balcony or Phase II Utility Platform and the covered area underneath such Phase II Balcony or Phase II Utility Platform to be enclosed above the safe parapet height other than as under the Phase II Approved Plans by any material of whatsoever kind or nature, and to keep and maintain any Phase II Balcony or Phase II Utility Platform in the design and layout as provided under the Phase II Approved Plans.

(b) Not to erect, affix or place or cause or permit or suffer or allow to be erected, affixed or placed any structure or partition of any material whether of a permanent or temporary nature on any Phase II Balcony or Phase II Utility Platform or any part thereof. |
| Not to hang washing | 5. Not to use or permit or suffer to be used any portion of any Unit, other than the place provided therein specifically therefor, for the washing or drying of clothes or any similar purpose or in any way which may alter the external appearance of the buildings or cause damage, nuisance, annoyance or inconvenience to the other Owners and occupiers of the Land and the Development. |
| Not to exhibit signs | 6. Not to exhibit on or at any window (either openable or non-openable) and/or entrance door and/or their associated frames of any Phase II Residential Unit any name, writing, drawing, signboard, plate, advertisement or placard of any kind which will be visible from the outside of the Phase II Residential Unit. |
| Not to misuse lavatories | 7. Not to use or permit or suffer to be used any water closet or other water apparatus on or in the Land and the Development (including those within the Phase II Residential Units) for any purpose other than that for which they are intended and not to throw or permit or suffer to be thrown into any water closet pan, urinal, basin, sink or other lavatory fitting any foreign or deleterious substance of any kind and to pay the Manager on demand the cost of any breakage, blockage or damage resulting from a breach of this provision. The cost of clearing any blockage and/or making good any breakage or damage resulting from their misuse will be charged to the person responsible or to the Owner of the Unit in which the problem originated. |
| Not to obstruct Common Areas | 8. (a) Not to use or cause or permit or suffer the use of any of the Estate Common Areas in Phase II, the Phase II Common Areas, the Phase II Residential Common Areas or the Phase II Car Park Common Areas for the |

purpose of drying laundry (except in the places specifically provided therefor) or hanging or placing or storing any article or thing thereon or therein and not to permit servants (or the children of any servant) or any other person to use the same for loitering or eating.

(b) Not to encumber or obstruct or permit or suffer to be encumbered or obstructed with any boxes, dustbins, packaging goods, rubbish, chattels or other obstruction of any kind or nature any of the Estate Common Areas in Phase II, the Phase II Common Areas, the Phase II Residential Common Areas or the Phase II Car Park Common Areas and the Manager shall be entitled without notice and at the Owner's expense to remove and dispose of as he sees fit any such material aforesaid and the Manager shall not thereby incur any liability to the Owner or any other person whomsoever and each and every Owner hereby agrees to keep the Manager indemnified against all losses, claims, damages or expenses of and against the Manager in respect thereof.

No erection of metal grilles and shutters

9. No Owner shall permit or suffer to be erected, affixed, installed or attached in or on or at the window or windows or door or doors or entrance or entrances of any Phase II Residential Unit any metal grille or shutter or gate which shall in any way contravene the regulations of the Fire Services Ordinance (Cap.95 of the Laws of Hong Kong) or other competent authority concerned from time to time in force and/or which may in any way impede the free and uninterrupted passage over, through and along any of the Phase II Residential Common Areas or the Phase II Residential Common Services and Facilities and the design of any metal grille or shutter or gate shall, prior to the installation thereof, first be submitted to the Manager for his approval in writing and the subsequent installation shall follow strictly the approved design and any conditions that may be imposed.

Not to obstruct driveways

10. Not to park in, obstruct or otherwise use or permit or suffer any servant, agent, visitor or licensee to park in, obstruct or otherwise use those areas of the Land and the Development allocated to the parking, movement or access of vehicles or designated as loading and unloading areas otherwise than in accordance with the Phase II House Rules from time to time made pursuant to Section G of this Deed or the Building Rules (if any) made pursuant to Section K of the Principal Deed.

Visitors' Car Parking Spaces

11. Subject to Clause 12 below, the Visitors' Car Parking Spaces, which form parts of the Phase II Residential Common Areas, shall be used only for the parking of motor vehicles licensed under the Road Traffic Ordinance (Cap.374 of the Laws of Hong Kong), any regulations made thereunder and any amending legislation, and belonging to the bona fide guests, visitors or invitees of the residents of the Phase II Residential Development and shall not be used for the storage, display or exhibiting of motor vehicles for sale or otherwise or for the provision of car cleaning and beauty services.

Disabled Car Parking Spaces

12. The Disabled Car Parking Spaces, which form parts of the Phase II Residential Common Areas, shall be used only for the parking of motor vehicles by disabled persons as defined in the Road Traffic Ordinance (Cap.374 of the Laws of Hong Kong), any regulations made thereunder and any amending legislation, and belonging to the residents of the Phase II Residential Development and their bona fide guests, visitors and invitees and shall not be used for the storage, display or exhibiting of motor vehicles for sale or otherwise or for the provision of car cleaning and beauty services.

Loading and unloading bays

13. The loading and unloading bays on Ground Floor of Phase II, which form parts of the Phase II Residential Common Areas, shall be used only for the purpose of loading and unloading of goods vehicles in connection with the building or buildings in Phase II by the Owners or residents of the Phase II Residential Development.

Phase II Greenery Area

14. Not to use the Phase II Greenery Area for any other purpose without the prior consent of the Building Authority.

Void

15. (a) The Void shall not be enclosed, partitioned, filled up, used for storage or any other purposes.

(b) No Owner may enter into, upon and through any part of the Void except that the Manager, MTR (as Owner of the MTR Portion) and the SCL Portion Owner may enter into, upon and through any part of the Void for the purpose of carrying out any work necessary for the maintenance and repair of Phase II, and for the purpose of exercising the right of the Owner of the MTR Portion in paragraph 3(a) of Part I of the Second Schedule to the Principal Deed and the right of the SCL Portion Owner in paragraph 4(b) of Part I of the Second Schedule to the Principal Deed respectively.

Height control and planting requirement

16. (a) Not to plant, grow, place, erect, affix or install or permit or suffer to be planted, grown, placed, erected, affixed or installed by his tenants, occupiers or licensees any plant, tree, furniture or other items on or in any Phase II Balcony, Phase II Utility Platform, air-conditioning platform, flat roof, roof and/or garden (if any and forming part of a Phase II Residential Unit) that exceeds the height of the parapet wall/glass panel and/or railing level thereof.

(b) Not to plant or grow or permit or suffer to be planted or grown by his tenants, occupiers or licensees any plant or tree in any garden forming part of a Phase II Residential Unit unless planted and carried in the large tank provided at the relevant Phase II Residential Unit on completion of the purchase by the first Owner of the relevant Phase II Residential Unit or other tank of such size and material to be from time to time specified by the Manager.

THE FOURTH SCHEDULE
PHASE II HOUSE RULES

1. (a) The purpose of the Phase II House Rules is to help maintain and preserve Phase II of the Estate as a high quality residential estate. They are for the benefit of all Owners of Phase II and residents and occupiers, on whom (together with their tenants, licensees, guests, servants and agents) they are binding.
- (b) The Phase II House Rules are supplementary to the Principal Deed and this Deed, the terms of which will prevail in the event of any conflict.
- (c) The Manager is empowered to enforce the Phase II House Rules and, from time to time as necessary, to amend or revoke them or make new rules in accordance with Section G of this Deed.
2. (a) The movement and parking of vehicles within Phase II is under the control of the Manager and all drivers must comply with directions given by the staff of the Manager.
- (b) The speed limit on Phase II is 20 kilometres per hour.
3. (a) No vehicle of any description, whether belonging to a resident or otherwise, may park anywhere on Phase II other than in one of the proper parking spaces provided for that purpose.
- (b) Each resident may park his motor vehicle(s) or motor cycle(s) (as the case may be) in his Phase II Car Parking Space(s) and must not use the Phase II Car Parking Space of any other resident without his prior consent.
- (c) Each Phase II Car Parking Space may be used only for the parking of one motor vehicle or one motor cycle (as the case may be); the carrying out of repairs and the storage of anything whatsoever is strictly prohibited.
- (d) No lorries, commercial or goods vehicles may be parked in any Phase II Car Parking Space (other than light vans or taxis belonging to an Owner or resident of the Residential Development), except that delivery vehicles and such like visiting Phase II on legitimate business may, as directed by the Manager, use spaces which are reserved for that purpose.
- (e) Any vehicle parked in contravention of the above rules, may be impounded or removed by the Manager without prior warning. The Manager may also, without liability to its owner, remove and dispose of any derelict vehicle which is an eyesore or otherwise causing nuisance to the residents (notwithstanding that it has been left in a designated parking space). All costs and charges incurred or levied by the Manager shall be recoverable from the owner of the vehicle impounded or removed.
4. The following matters require the prior written consent of the Manager, which may be granted, withheld (such consent shall not be unreasonably withheld), or granted subject to conditions at its absolute discretion, and work must not commence unless and until such consent has been obtained :-
 - (a) the installation of air-conditioners and any similar or related plant or equipment (other than the usual domestic type air-conditioning units at the air-conditioning platforms appertaining to the Phase II Residential Unit), subject to the Manager's right to require such subsequent modifications (or complete removal) of any installed air-conditioners or similar or related plant or equipment (whether or not the installation of the same requires the Manager's consent under this Clause) as they may deem necessary including, without limitation, the taking of measures to avoid condensation dripping on the premises below; and
 - (b) the installation and/or use of window guard,

PROVIDED THAT the Manager must not charge any fee other than a reasonable administrative fee for issuing consent and such fee must be credited to the relevant account of the Special Fund for Phase II.

5. No washing may be hung on or anything projected from or out of any roof, flat roof, Phase II Balcony, Phase II Utility Platform or window of the Phase II Residential Units.

6. Each resident is required to keep his Unit in a good state of preservation and cleanliness and is responsible for ensuring that no dirt, garbage, waste or other matter is dropped, swept or thrown outside onto the Common Areas, or the premises of any other resident.
7. Garbage and refuse from each Unit shall be removed and handled in such manner as the Manager may direct.
8. Residents must not play or operate any musical instrument, radio, television, recording equipment or such like, or cause or permit or suffer any noise to emanate from their Units to the disturbance or annoyance of other residents.
9. The Phase II Residential Units are to be used for residential purposes only and must not be used for or in connection with any business or for gambling or any illegal or immoral purpose.
10. Notwithstanding Clause 1(x) in the Third Schedule of the Principal Deed, no Owner or resident shall bring or keep in any Unit any dogs, cats, pets, live poultry or other animals which may be the subject of reasonable complaint from the other Owners or residents PROVIDED THAT this provision shall not apply to guide dogs required for persons with disability in vision.
11. The Manager is empowered to make, revoke and amend the Fitting Out Rules relating to the carrying out of work to any Unit and regulations governing the use and enjoyment of the swimming pool(s) and all other recreational facilities to be used by the residents and occupiers of the Phase II Residential Development and their bona fide visitors.
12. Residents are not permitted to utilise any employee of the Manager or any of the staff of Phase II for their own private business or purposes.
13. Any consent or approval under the Phase II House Rules given by the Manager may be revoked at any time PROVIDED THAT such consent or approval shall not be revoked unreasonably.
14. Any queries or complaints in regard to any matter concerning Phase II should be made to the Manager, preferably in writing.

THE FIFTH SCHEDULE
PHASE II WORKS AND INSTALLATIONS

1. structural elements;
2. external wall finishes and roofing materials;
3. fire safety elements;
4. plumbing system;
5. drainage system;
6. fire services installations and equipment;
7. electrical wiring system;
8. lift installations;
9. gas supply system;
10. curtain walls/cladding/window installations;
11. ventilation and air conditioning systems;
12. the Noise Mitigation Measures in Phase II;
13. the Slopes and Retaining Walls in Phase II as for identification purpose only shown and coloured grey on the plans certified as to their accuracy by the Authorized Person and annexed hereto;
14. building maintenance unit including gondolas, spider maintenance platform and vertical working platform;
15. soft and hard landscape works;
16. telecommunication systems;
17. carpark control system;
18. security system; and
19. swimming pool and water feature filtration systems.

THE SIXTH SCHEDULE

PHASE II BALCONIES

<u>Tower</u>	<u>Floor</u>	<u>Flat/Penthouse which has a Phase II Balcony</u>
Tower 1	2/F - 15/F	Flats A, B, C, D, E, F & G
	16/F - 26/F	Flats A, B, C & D
	27/F	Flats A & B
	28/F	Penthouses A & B
Tower 2	2/F - 15/F	Flats A, B, C, D, E, F & G
	16/F - 26/F	Flats A, B, C, D & E
	27/F	Flats A, B & C
	28/F	Penthouse A, Flats B & C
Tower 3	2/F - 15/F	Flats A, B, C, D, E, F & G
	16/F - 26/F	Flats A, B, C, D, E & F
	27/F	Flats A, B & C
	28/F	Penthouse A, Flats B & C
Tower 5(5A)	2/F - 27/F	Flats A, B, C, D, E & F
	28/F	Flats A, C, D, E & F
Tower 5(5B)	2/F - 27/F	Flats A, B, C, D, E & F
	28/F	Flats A, C, D, E & F
Tower 6(6A)	2/F - 27/F	Flats A, B, C, D, E & F
	28/F	Flats A, B, C, D & E
Tower 6(6B)	2/F - 27/F	Flats A, B, C, D, E & F
	28/F	Flats A, C, D, E & F

Notes:

1. There are no designations of 4/F, 13/F, 14/F and 24/F of all Towers.
2. There is no designation of Tower 4.

PHASE II UTILITY PLATFORMS

<u>Tower</u>	<u>Floor</u>	<u>Flat/Penthouse which has a Phase II Utility Platform</u>
Tower 1	2/F - 15/F	Flats A, B, C, D, E, F & G
	16/F - 26/F	Flats A, B, C & D
	27/F	Flats A & B
	28/F	Penthouses A & B
Tower 2	2/F - 15/F	Flats A, B, C, D, E, F & G
	16/F - 26/F	Flats A, B, C, D & E
	27/F	Flats A, B & C
	28/F	Penthouse A, Flats B & C
Tower 3	2/F - 15/F	Flats A, B, C, D, E, F & G
	16/F - 26/F	Flats A, B, C, D, E & F
	27/F	Flats A, B & C
	28/F	Penthouse A, Flats B & C
Tower 5(5A)	2/F - 27/F	Flats A, B, C, D, E & F
	28/F	Flats A, C, D, E & F
Tower 5(5B)	2/F - 27/F	Flats A, B, C, D, E & F
	28/F	Flats A, C, D, E & F
Tower 6(6A)	2/F - 27/F	Flats A, B, C, D, E & F
	28/F	Flats A, B, C, D & E
Tower 6(6B)	2/F - 27/F	Flats A, B, C, D, E & F
	28/F	Flats A, C, D, E & F

Notes:

1. There are no designations of 4/F, 13/F, 14/F and 24/F of all Towers.
2. There is no designation of Tower 4.







SIGNED SEALED and DELIVERED)
by)
)
the lawful attorney of MTR Corporation Limited)
in its capacity as registered owner of the Units in)
Phase II of the Estate (except the First Assigned)
Premises) whose signature is verified by :-)

SIGNED SEALED and DELIVERED)
by the Purchaser in the presence of :-)

SIGNED SEALED and DELIVERED)
by)
)
[])
as the Manager whose signature is verified by :-)



LEGEND

-  PHASE II RESIDENTIAL COMMON AREAS
-  PHASE II RECREATIONAL AREAS AND FACILITIES
-  PHASE II COMMON AREAS
-  PHASE II GREENERY AREA
-  SLOPES AND RETAINING WALLS IN PHASE II
-  UNEXCAVATED
-  PEDESTRIAN LINK IN PHASE II



呂元祥建築師事務所

Project Title
**HO MAN TIN STATION
 PHASE II PROPERTY
 DEVELOPMENT AT KIL. NO.
 11264, HO MAN TIN, KOWLOON**

Drawing Title
**LOWER GROUND 4
 FLOOR PLAN**

Project No. 17025KL.01
 Scale 1:500 Issue Date 14 JUL 2023
 Drawing No. A / DMC / 01 (REV. E)

AP's Signature
 I HEREBY CERTIFY THE ACCURACY
 OF THIS PLAN.

CHEUNG Man-Ching, Anthony
 Authorized Person (Architect)
 14-07-2023

0m 5m 15m 30m

THIS PLAN IS FOR IDENTIFICATION PURPOSE ONLY



- LEGEND**
- PHASE II RESIDENTIAL COMMON AREAS
 - PHASE II RECREATIONAL AREAS AND FACILITIES
 - PHASE II COMMON AREAS
 - PHASE II GREENERY AREA INCLUDING:
 - GW VERTICAL GREENERY AREA
 - GY SLOPES AND RETAINING WALLS IN PHASE II
 - UNEXCAVATED



呂元祥建築師事務所

Project Title
**HO MAN TIN STATION
 PHASE II PROPERTY
 DEVELOPMENT AT KIL. NO.
 11264, HO MAN TIN, KOWLOON**

Drawing Title
**LOWER GROUND 3
 FLOOR PLAN**

Project No. 17025KL.01
 Scale 1:500 Issue Date 14 JUL 2023
 Drawing No. A/DMC/02 (REV. E)

AP's Signature
 I HEREBY CERTIFY THE ACCURACY
 OF THIS PLAN.

CHEUNG Man Ching, Anthony
 Authorized Person (Architect)
 14-07-2023

0m 5m 15m 30m
 THIS PLAN IS FOR IDENTIFICATION PURPOSE ONLY



LEGEND

- PHASE II RESIDENTIAL COMMON AREAS
- PHASE II RECREATIONAL AREAS AND FACILITIES
- PHASE II COMMON AREAS
- PHASE II CAR PARK COMMON AREAS
- PHASE II GREENERY AREA INCLUDING:
- GW VERTICAL GREENERY AREA
- UNEXCAVATED
- GY SLOPES AND RETAINING WALLS IN PHASE II



呂元祥建築師事務所

Project Title
**HO MAN TIN STATION
 PHASE II PROPERTY
 DEVELOPMENT AT KIL. NO.
 11264, HO MAN TIN, KOWLOON**

Drawing Title
**LOWER GROUND 2
 FLOOR PLAN**

Project No. 17025KL.01
 Scale 1:500 Issue Date 14 JUL 2023
 Drawing No. A/DMC/03 (REV. E)

AP's Signature
 I HEREBY CERTIFY THE ACCURACY
 OF THIS PLAN.

CHEUNG Man-Ching, Anthony
 Authorized Person (Architect)
 14-07-2023



THIS PLAN IS FOR IDENTIFICATION PURPOSE ONLY



LEGEND

- PHASE II RESIDENTIAL COMMON AREAS
- PHASE II RECREATIONAL AREAS AND FACILITIES
- PHASE II COMMON AREAS
- PHASE II CAR PARK COMMON AREAS
- PHASE II GREENERY AREA INCLUDING:
 - GW VERTICAL GREENERY AREA
 - UNEXCAVATED
 - GY SLOPES AND RETAINING WALLS IN PHASE II



THIS PLAN IS FOR IDENTIFICATION PURPOSE ONLY



呂元祥建築師事務所

Project Title
**HO MAN TIN STATION
 PHASE II PROPERTY
 DEVELOPMENT AT KIL. NO.
 11264, HO MAN TIN, KOWLOON**

Drawing Title
**LOWER GROUND 1
 FLOOR PLAN**

Project No. 17025KL.01
 Scale 1:500 Issue Date 14 JUL 2023
 Drawing No. A/DMC/04 (REV. E)

AP's Signature
 I HEREBY CERTIFY THE ACCURACY
 OF THIS PLAN.

CHEUNG Man-shing, Anthony
 Authorized Person (Architect)
 14-07-2023



- LEGEND**
- PHASE II RESIDENTIAL COMMON AREAS
 - PHASE II RECREATIONAL AREAS AND FACILITIES
 - PHASE II COMMON AREAS
 - PHASE II CAR PARK COMMON AREAS
 - ESTATE COMMON AREAS IN PHASE II
 - PHASE II GREENERY AREA INCLUDING:
 - VERTICAL GREENERY AREA
 - PEDESTRIAN LINK IN PHASE II
 - COVERED WALKWAY

PHASE II GREENERY AREA (INCLUDING VERTICAL GREENERY AREA)
 LG4/F TO G/F = 4225.072s.m.
 TOTAL GREENERY = 4225.072s.m. AREA



呂元祥建築師事務所

Project Title
**HO MAN TIN STATION
 PHASE II PROPERTY
 DEVELOPMENT AT KIL. NO.
 11264, HO MAN TIN, KOWLOON**

Drawing Title
GROUND FLOOR PLAN

Project No. 17025KL.01
 Scale 1:500 Issue Date 14 JUL 2023
 Drawing No. A/DMC/05 (REV. E)

AP's Signature
 I HEREBY CERTIFY THE ACCURACY
 OF THIS PLAN.

CHEUNG Man-ching, Anthony
 Authorized Person (Architect)
 14-07-2023

0m 5m 15m 30m
 THIS PLAN IS FOR IDENTIFICATION PURPOSE ONLY

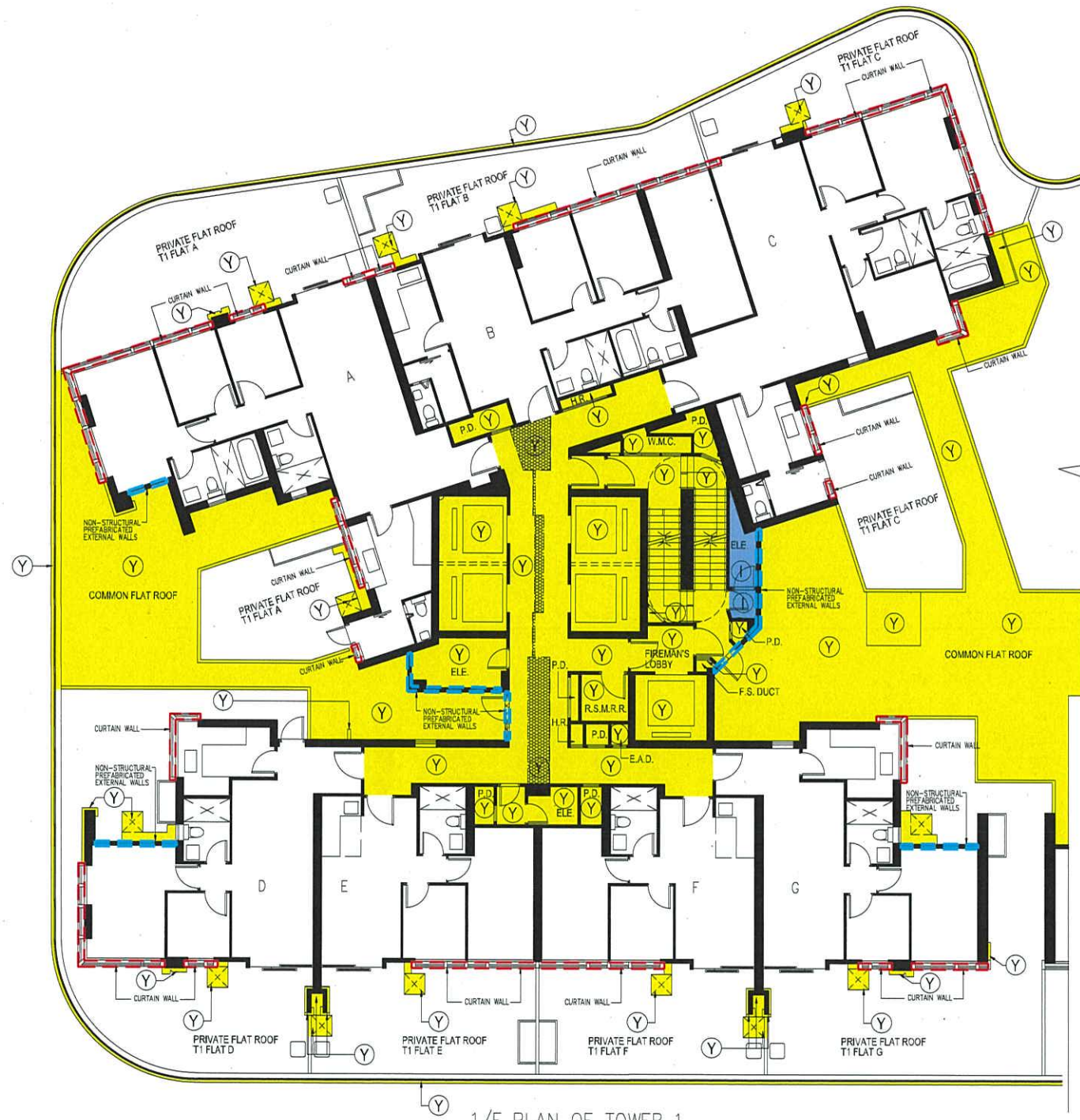

1/F PLAN OF TOWER 1

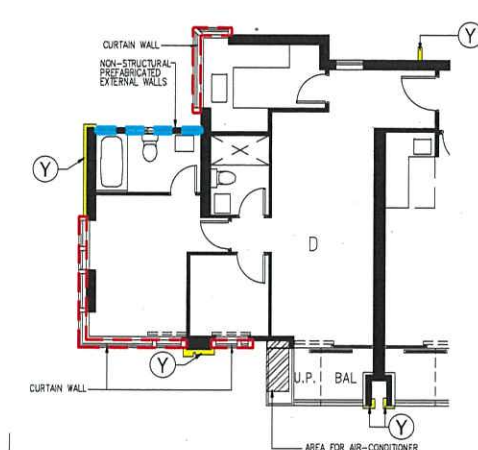

15/F FLAT D PART PLAN OF TOWER 1

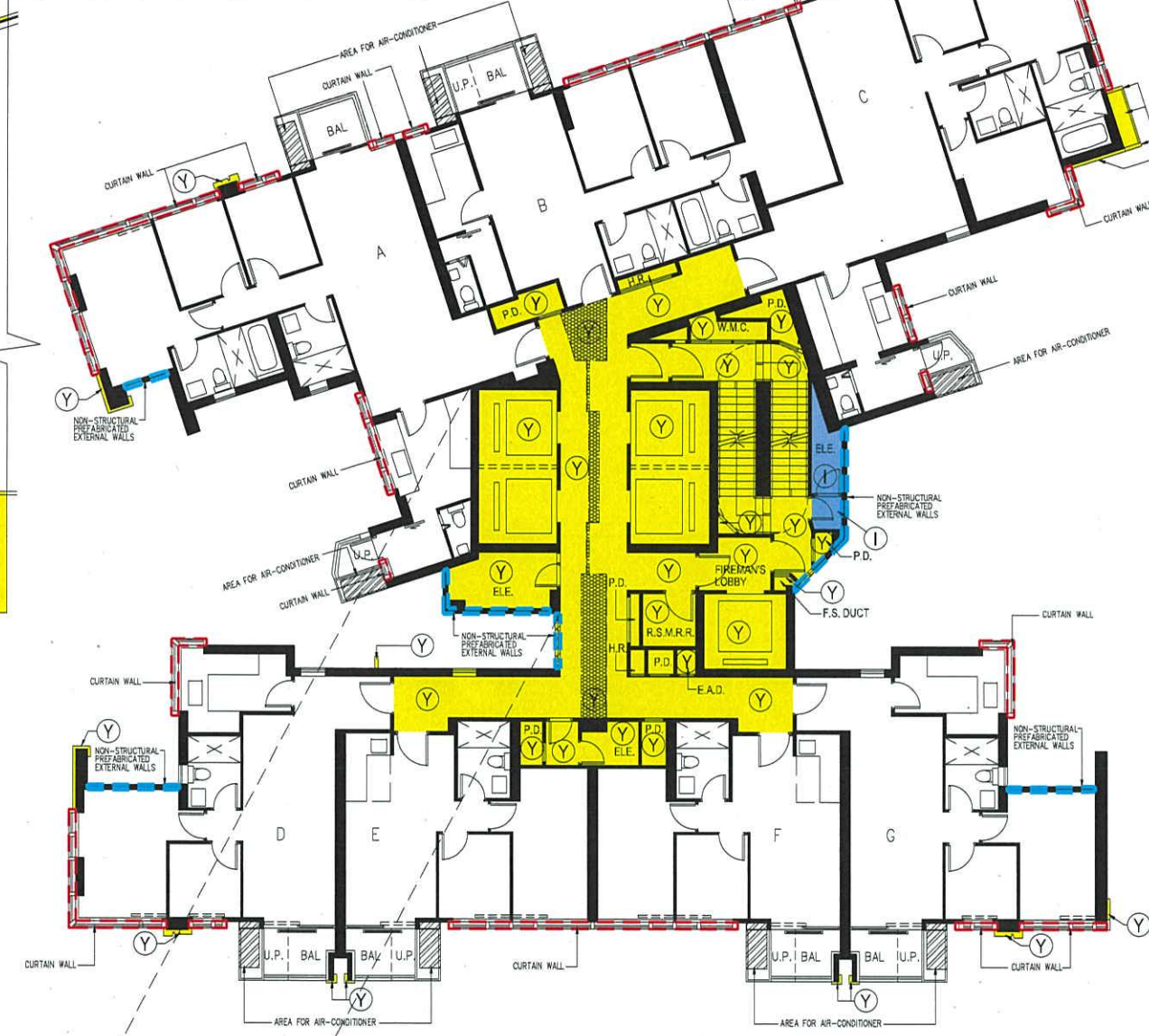

2/F-15/F PLAN OF TOWER 1
(11 STOREYS) (OMITTED 4/F, 13/F AND 14/F)

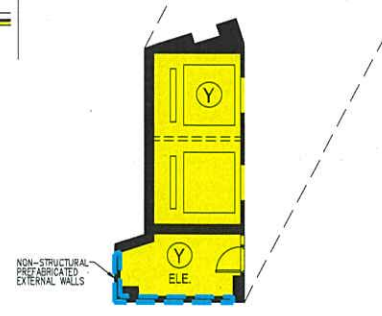

2/F PART PLAN OF TOWER 1



- LEGEND**
- Y PHASE II RESIDENTIAL COMMON AREAS
 - CURTAIN WALL
 - NON-STRUCTURAL PREFABRICATED EXTERNAL WALLS
 - AREA FOR AIR-CONDITIONER (AIR-CONDITIONING PLATFORM) (NON-ENCLOSED AREA)
 - PHASE II RESIDENTIAL COMMON AREAS (WIDER COMMON CORRIDOR)
 - I PHASE II COMMON AREAS
 - BAL = PHASE II BALCONY
 - U.P. = PHASE II UTILITY PLATFORM



呂元祥建築師事務所

Project Title
HO MAN TIN STATION
PHASE II PROPERTY
DEVELOPMENT AT KIL. NO.
11264, HO MAN TIN, KOWLOON

Drawing Title
TOWER 1 FLOOR PLANS (1)

Project No. 17025KL.01
Scale 1:200 Issue Date 14 JUL 2023
Drawing No. A/DMC/06 (REV. E)

AP's Signature
I HEREBY CERTIFY THE ACCURACY
OF THIS PLAN.

CHEUNG Man-Ching, Anthony
Authorized Person (Architect)
14-07-2023

0m 1m 3m 5m

THIS PLAN IS FOR IDENTIFICATION PURPOSE ONLY



- LEGEND**
- Y PHASE II RESIDENTIAL COMMON AREAS
 - CURTAIN WALL
 - NON-STRUCTURAL PREFABRICATED EXTERNAL WALLS
 - AREA FOR AIR-CONDITIONER (AIR-CONDITIONING PLATFORM) (NON-ENCLOSED AREA)
 - PHASE II RESIDENTIAL COMMON AREAS (WIDER COMMON CORRIDOR)
 - 1 PHASE II COMMON AREAS
 - BAL = PHASE II BALCONY
 - U.P. = PHASE II UTILITY PLATFORM

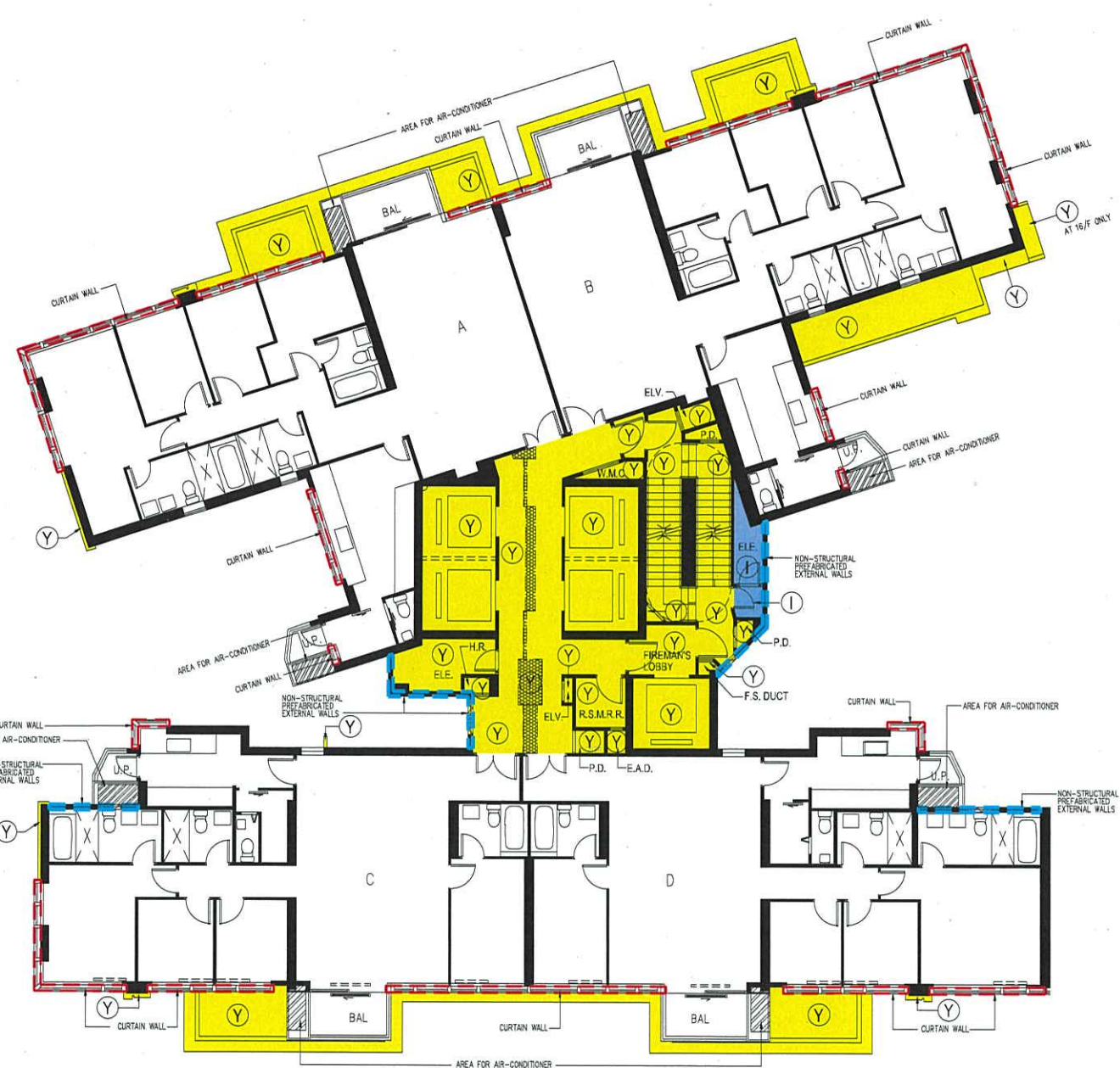

16/F-26/F PLAN OF TOWER 1
(10 STOREYS) (OMITTED 24/F)



27/F PLAN OF TOWER 1

0m 1m 3m 5m

THIS PLAN IS FOR IDENTIFICATION PURPOSE ONLY



呂元祥建築師事務所

Project Title
**HO MAN TIN STATION
PHASE II PROPERTY
DEVELOPMENT AT KIL. NO.
11264, HO MAN TIN, KOWLOON**

Drawing Title
TOWER 1 FLOOR PLANS (2)







Project No. 17025KL.01
Scale 1:200 Issue Date 14 JUL 2023
Drawing No. A/DMC/07 (REV. E)

AP's Signature
I HEREBY CERTIFY THE ACCURACY
OF THIS PLAN.

CHEUNG Man-Ching, Anthony
Authorized Person (Architect)
14-07-2023



LEGEND

-  PHASE II RESIDENTIAL COMMON AREAS
-  CURTAIN WALL
-  NON-STRUCTURAL PREFABRICATED EXTERNAL WALLS
-  AREA FOR AIR-CONDITIONER (AIR-CONDITIONING PLATFORM) (NON-ENCLOSED AREA)
-  PHASE II RESIDENTIAL COMMON AREAS (WIDER COMMON CORRIDOR)
-  PHASE II COMMON AREAS
- BAL = PHASE II BALCONY
- U.P. = PHASE II UTILITY PLATFORM

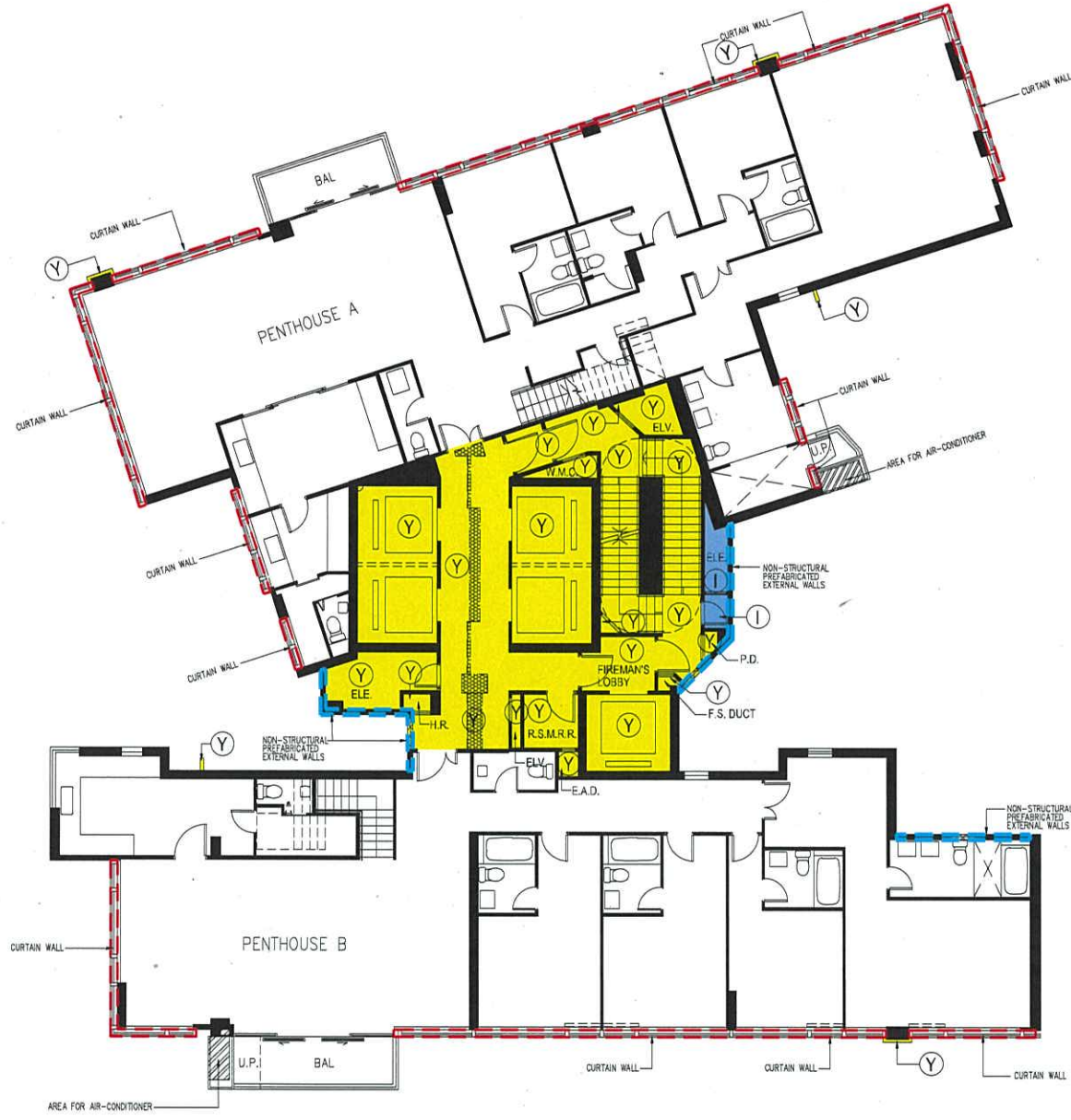

28/F PLAN OF TOWER 1

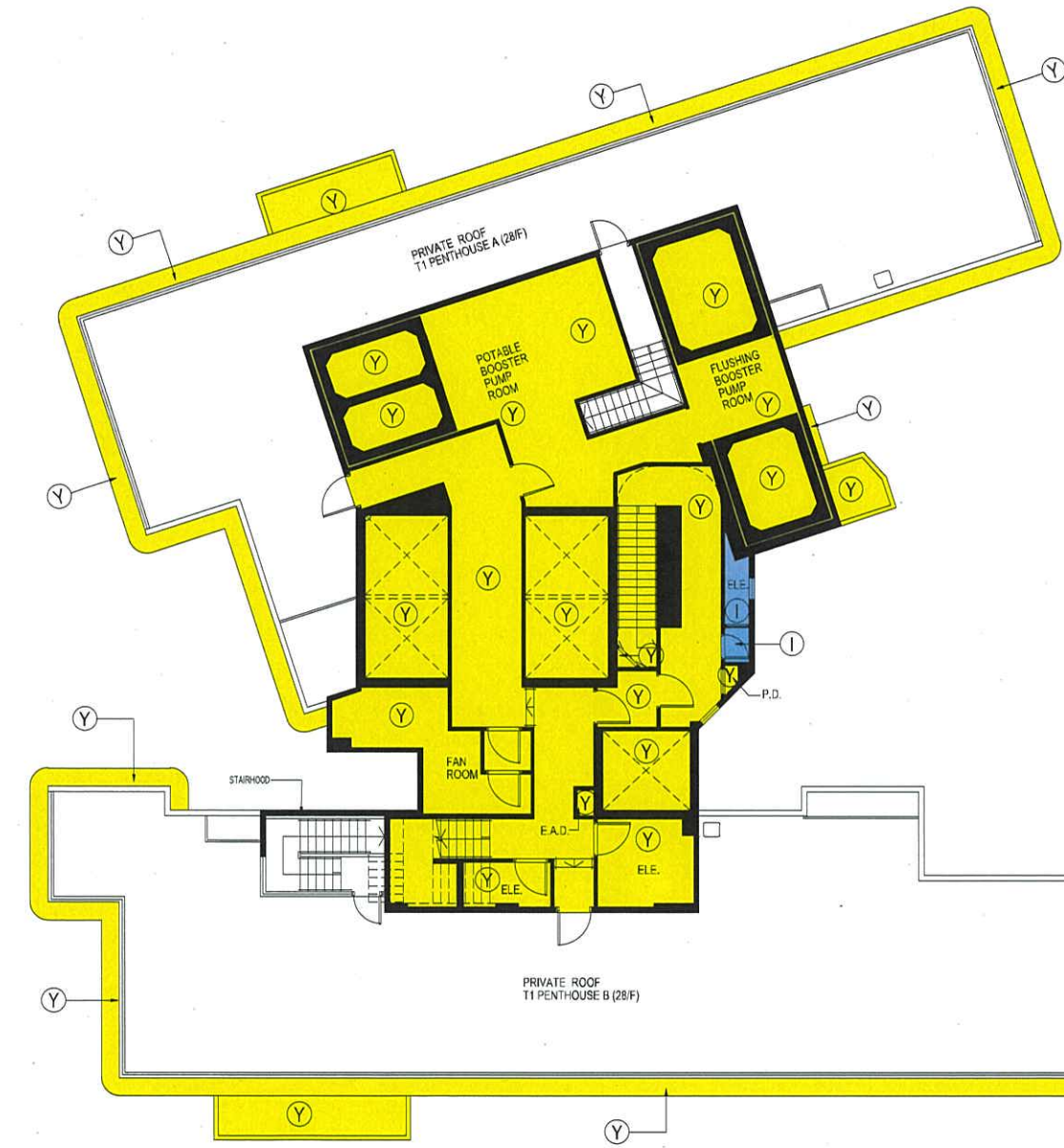

ROOF PLAN OF TOWER 1

0m 1m 3m 5m

THIS PLAN IS FOR IDENTIFICATION PURPOSE ONLY



呂元祥建築師事務所

Project Title
**HO MAN TIN STATION
 PHASE II PROPERTY
 DEVELOPMENT AT KIL. NO.
 11264, HO MAN TIN, KOWLOON**

Drawing Title
 TOWER 1 FLOOR PLANS (3)

Project No. 17025KL.01
 Scale 1:200 Issue Date 14 JUL 2023
 Drawing No. A/DMC/08 (REV. E)

AP's Signature
 I HEREBY CERTIFY THE ACCURACY
 OF THIS PLAN.

CHEUNG Man-Ching, Anthony
 Authorized Person (Architect)
 14-07-2023



LEGEND



PHASE II RESIDENTIAL COMMON AREAS



PHASE II COMMON AREAS

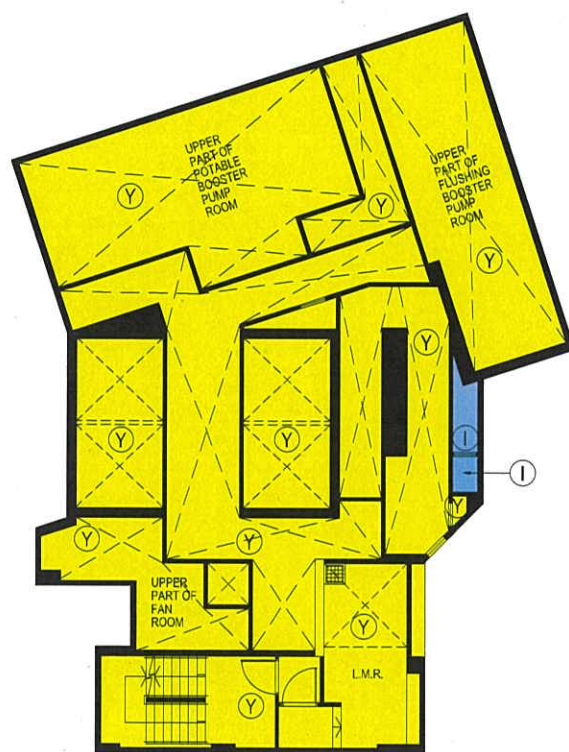

L.M.R. LEVEL PART PLAN OF TOWER 1

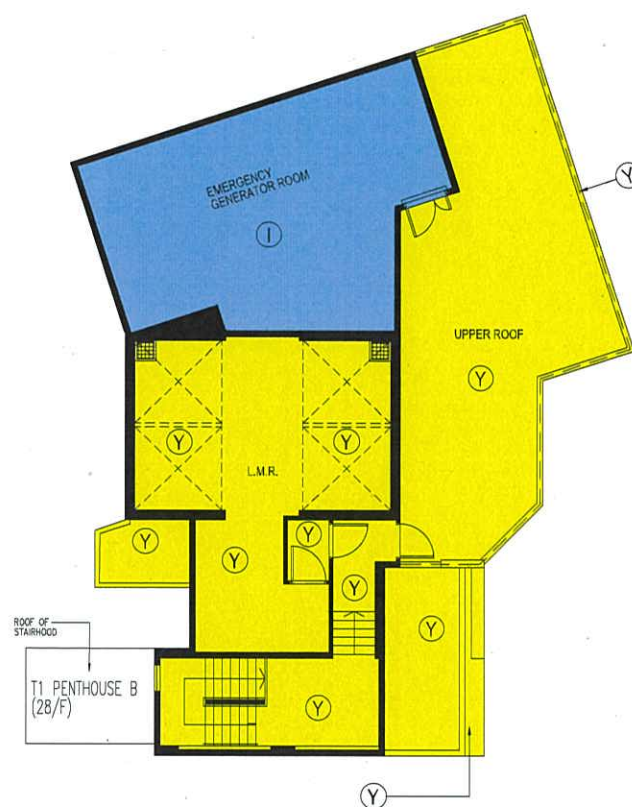

UPPER ROOF PLAN OF TOWER 1

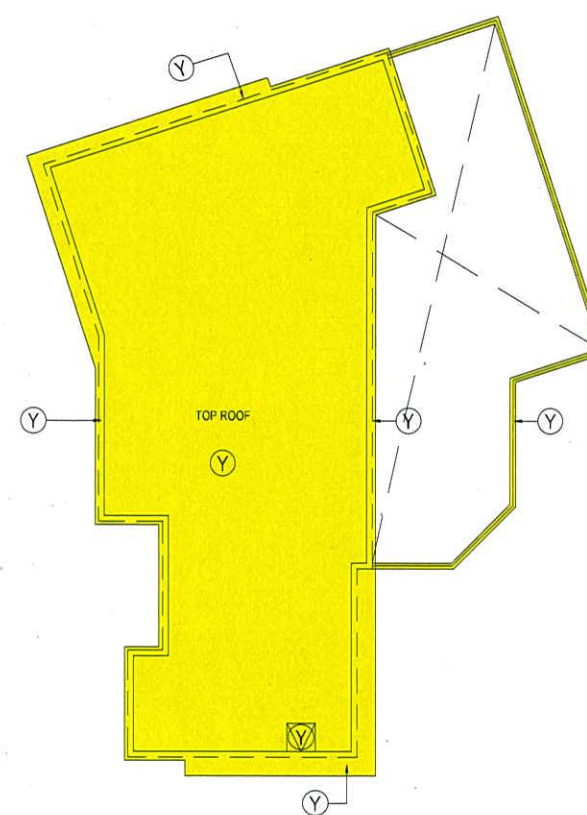

TOP ROOF PLAN OF TOWER 1

0m 1m 3m 5m

THIS PLAN IS FOR IDENTIFICATION PURPOSE ONLY



呂元祥建築師事務所

Project Title
HO MAN TIN STATION
PHASE II PROPERTY
DEVELOPMENT AT KIL. NO.
11264, HO MAN TIN, KOWLOON

Drawing Title
TOWER 1 FLOOR PLANS (4)

Project No. 17025KL.01
Scale 1:200 Issue Date 14 JUL 2023
Drawing No. A/DMC/09 (REV. E)

AP's Signature
I HEREBY CERTIFY THE ACCURACY
OF THIS PLAN.

CHEUNG Man-Ching, Anthony
Authorized Person (Architect)
14-07-2023

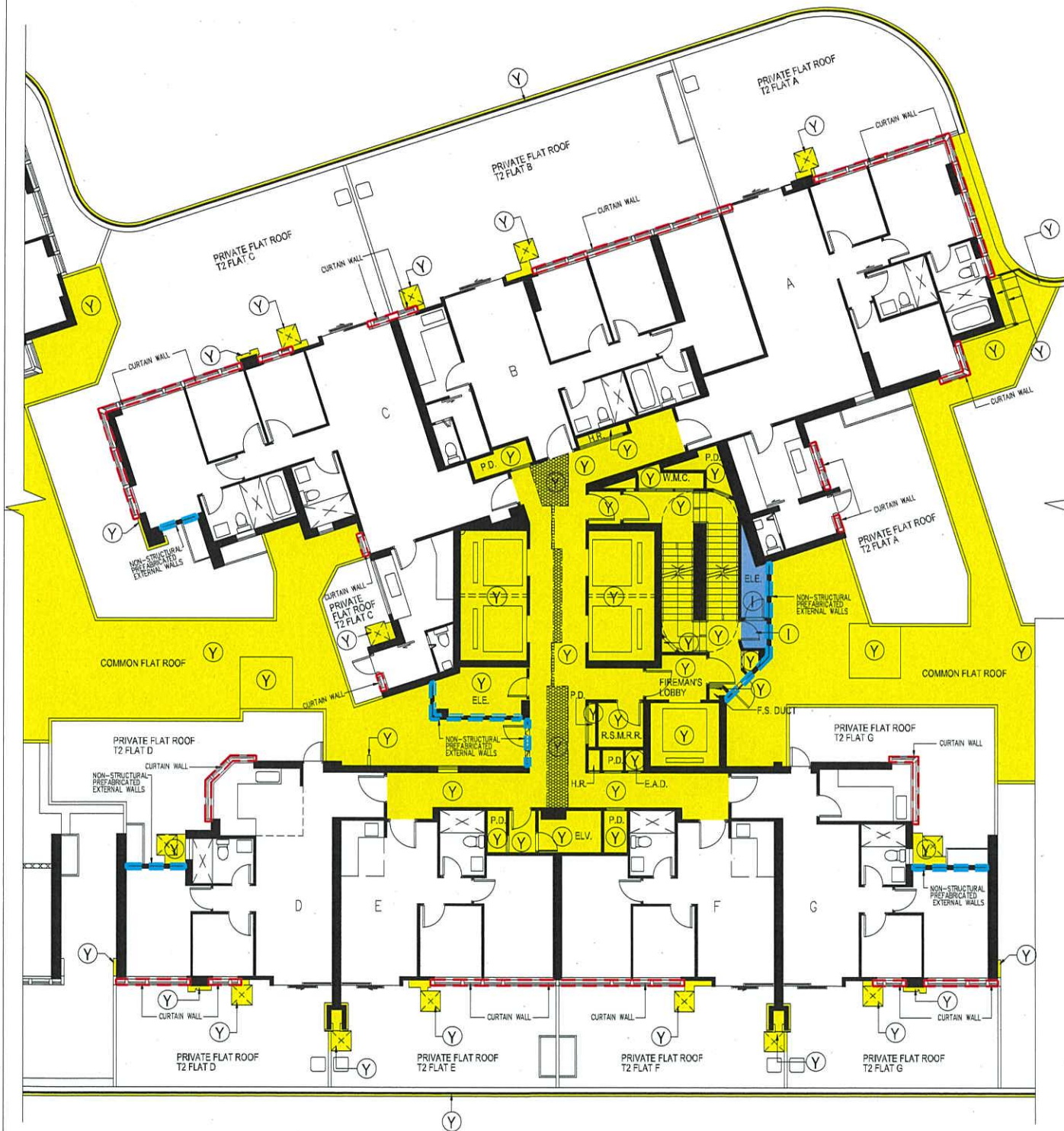

1/F PLAN OF TOWER 2

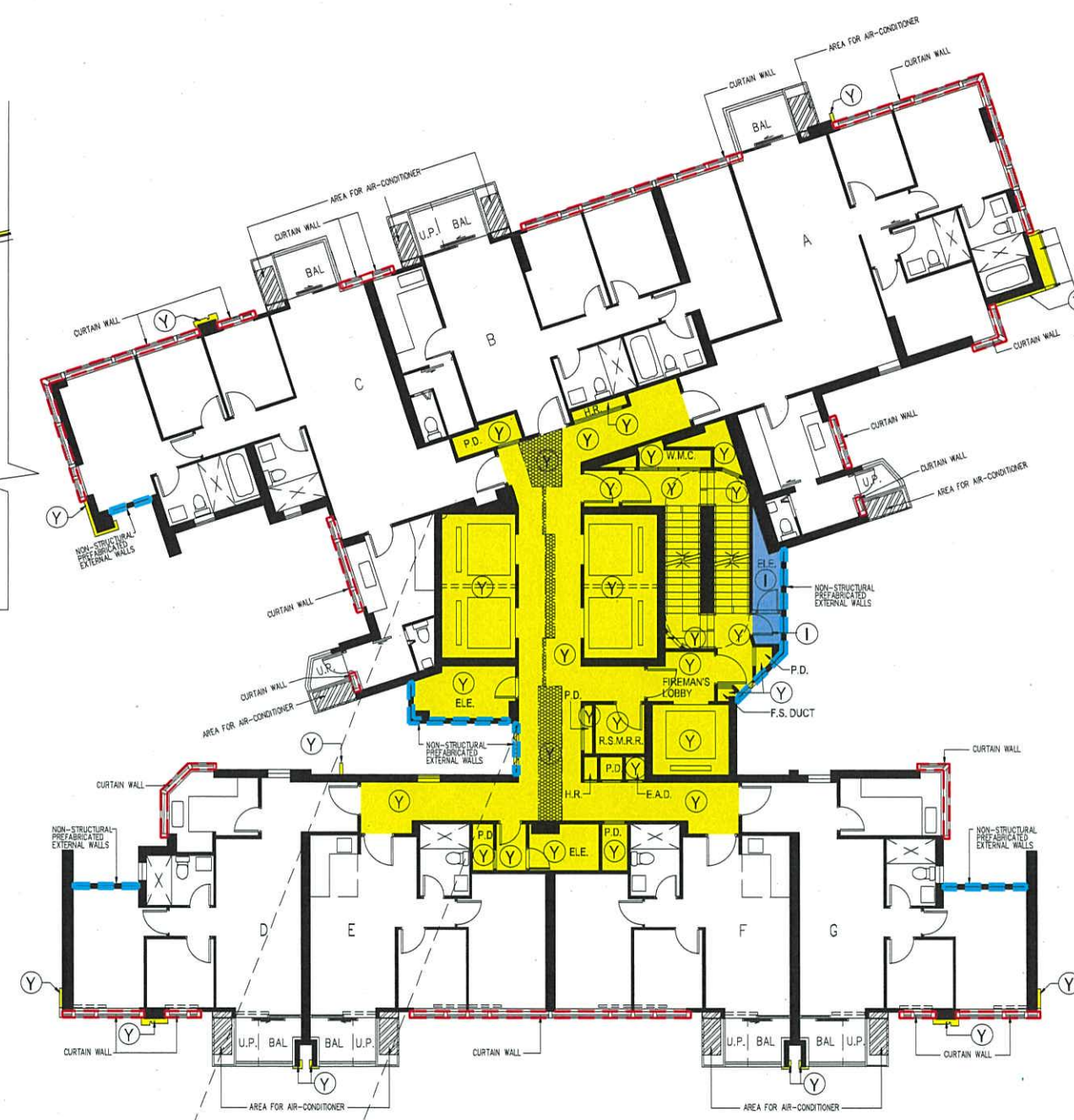

2/F-15/F PLAN OF TOWER 2
(11 STOREYS) (OMITTED 4/F, 13/F AND 14/F)

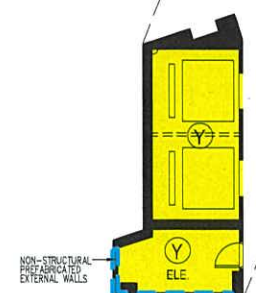

2/F PART PLAN OF TOWER 2



LEGEND

- Y PHASE II RESIDENTIAL COMMON AREAS
- CURTAIN WALL
- NON-STRUCTURAL PREFABRICATED EXTERNAL WALLS
- AREA FOR AIR-CONDITIONER (AIR-CONDITIONING PLATFORM) (NON-ENCLOSED AREA)
- PHASE II RESIDENTIAL COMMON AREAS (WIDER COMMON CORRIDOR)
- I PHASE II COMMON AREAS
- BAL = PHASE II BALCONY
- U.P. = PHASE II UTILITY PLATFORM



呂元祥建築師事務所

Project Title
HO MAN TIN STATION
PHASE II PROPERTY
DEVELOPMENT AT KIL. NO.
11264, HO MAN TIN, KOWLOON

Drawing Title
TOWER 2 FLOOR PLANS (1)

Project No. 17025KL.01
Scale 1:200 Issue Date 14 JUL 2023
Drawing No. A/DMC/10 (REV. E)

AP's Signature
I HEREBY CERTIFY THE ACCURACY
OF THIS PLAN.

CHEUNG Man-Ching, Anthony
Authorized Person (Architect)
14-07-2023

0m 1m 3m 5m

THIS PLAN IS FOR IDENTIFICATION PURPOSE ONLY



- LEGEND**
- Y PHASE II RESIDENTIAL COMMON AREAS
 - CURTAIN WALL
 - NON-STRUCTURAL PREFABRICATED EXTERNAL WALLS
 - AREA FOR AIR-CONDITIONER (AIR-CONDITIONING PLATFORM) (NON-ENCLOSED AREA)
 - PHASE II RESIDENTIAL COMMON AREAS (WIDER COMMON CORRIDOR)
 - I PHASE II COMMON AREAS
 - BAL = PHASE II BALCONY
 - U.P. = PHASE II UTILITY PLATFORM

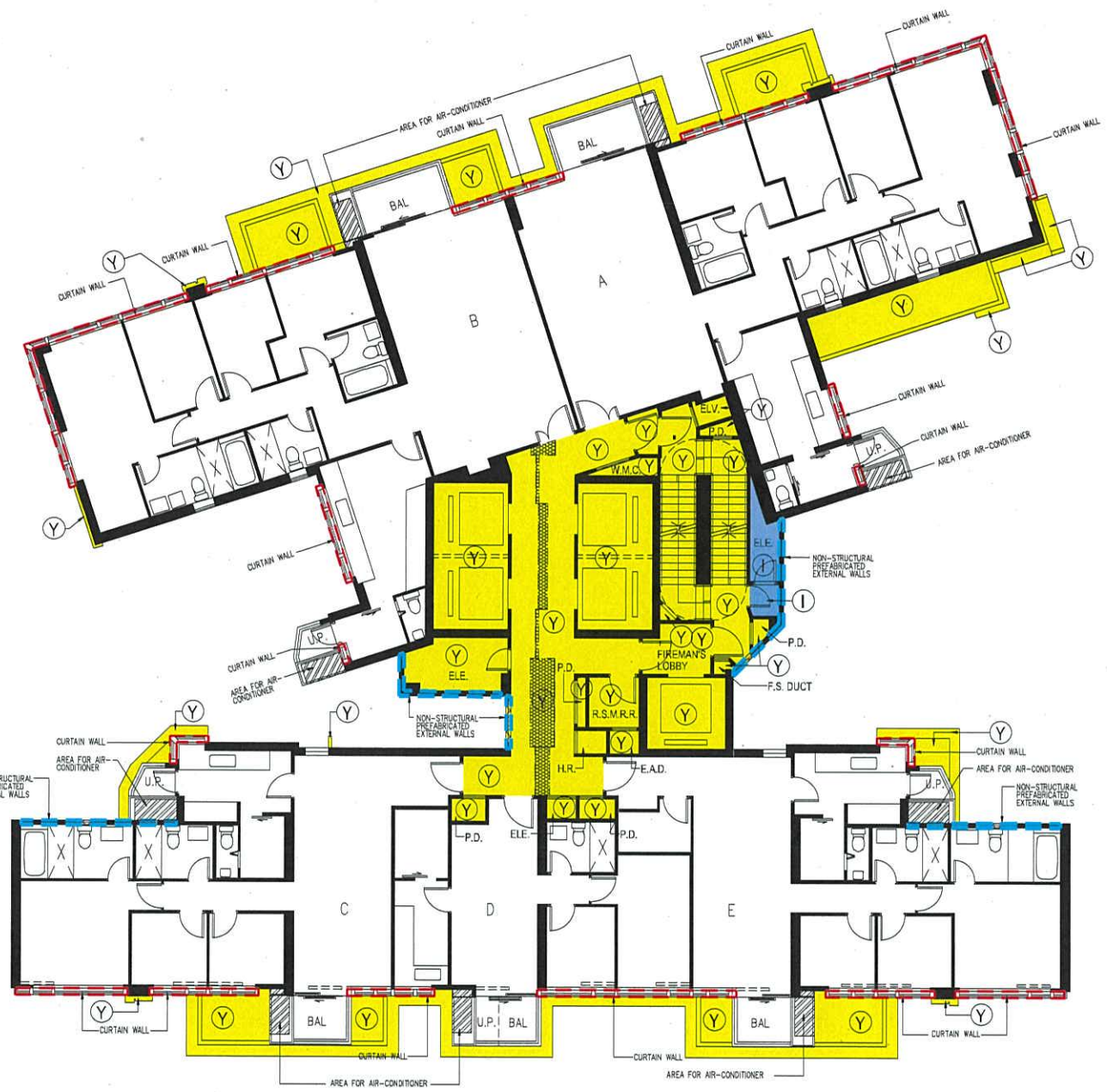

16/F-26/F PLAN OF TOWER 2
(10 STOREYS) (OMITTED 24/F)



27/F PLAN OF TOWER 2



呂元祥建築師事務所

Project Title
**HO MAN TIN STATION
PHASE II PROPERTY
DEVELOPMENT AT KIL. NO.
11264, HO MAN TIN, KOWLOON**

Drawing Title
TOWER 2 FLOOR PLANS (2)

Project No. 17025KL.01
Scale 1:200 Issue Date 14 JUL 2023
Drawing No. A/DMC/11 (REV. E)

AP's Signature
I HEREBY CERTIFY THE ACCURACY
OF THIS PLAN.







CHEUNG Man-Ching, Anthony
Authorized Person (Architect)
14-07-2023

0m 1m 3m 5m

THIS PLAN IS FOR IDENTIFICATION PURPOSE ONLY



LEGEND

-  PHASE II RESIDENTIAL COMMON AREAS
-  CURTAIN WALL
-  NON-STRUCTURAL PREFABRICATED EXTERNAL WALLS
-  AREA FOR AIR-CONDITIONER (AIR-CONDITIONING PLATFORM) (NON-ENCLOSED AREA)
-  PHASE II RESIDENTIAL COMMON AREAS (WIDER COMMON CORRIDOR)
-  PHASE II COMMON AREAS
- BAL = PHASE II BALCONY
- U.P. = PHASE II UTILITY PLATFORM

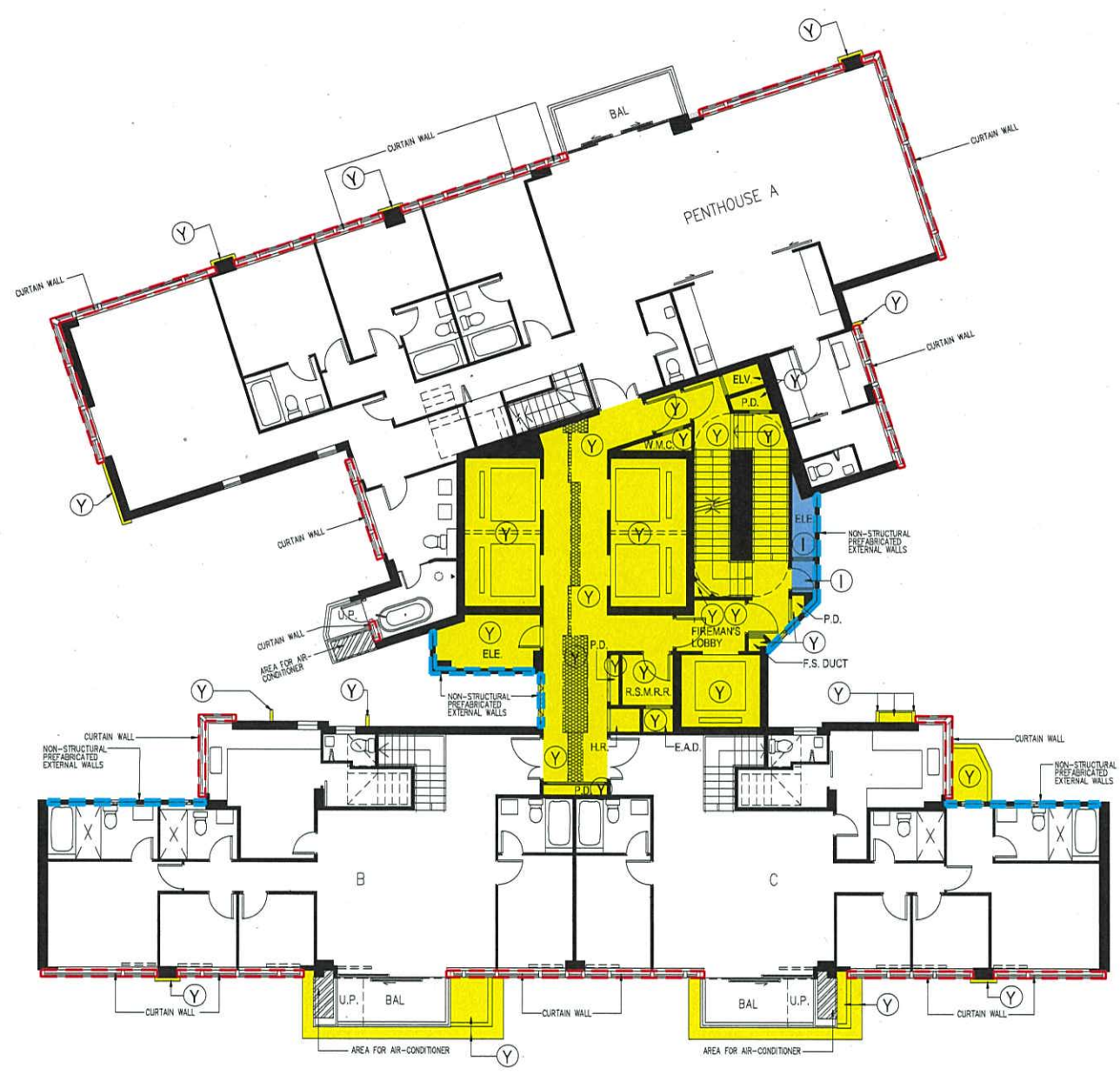

28/F PLAN OF TOWER 2



ROOF PLAN OF TOWER 2

0m 1m 3m 5m

THIS PLAN IS FOR IDENTIFICATION PURPOSE ONLY



呂元祥建築師事務所

Project Title
**HO MAN TIN STATION
 PHASE II PROPERTY
 DEVELOPMENT AT KIL. NO.
 11264, HO MAN TIN, KOWLOON**

Drawing Title
 TOWER 2 FLOOR PLANS (3)

Project No. 17025KL.01
 Scale 1:200 Issue Date 14 JUL 2023
 Drawing No. A/DMC/12 (REV. E)

AP's Signature
 I HEREBY CERTIFY THE ACCURACY
 OF THIS PLAN.

CHEUNG Man-Cing, Anthony
 Authorized Person (Architect)
 14-07-2023



LEGEND

 PHASE II RESIDENTIAL COMMON AREAS

 PHASE II COMMON AREAS

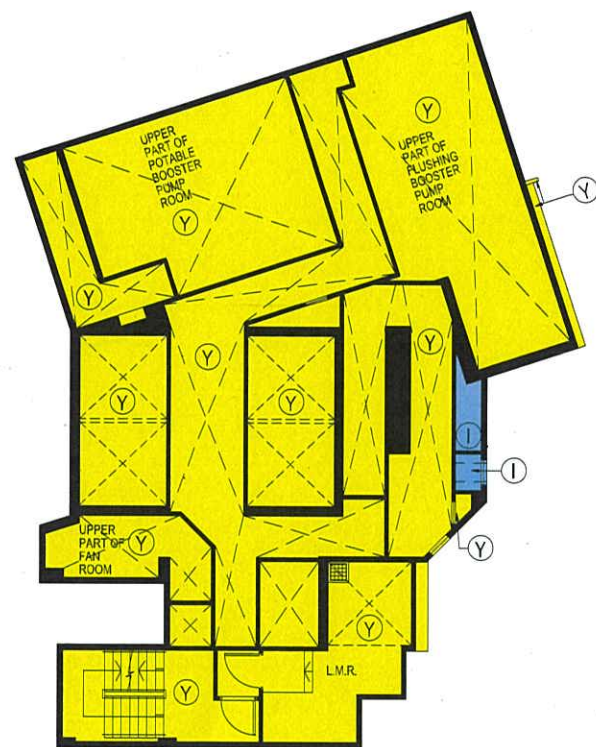

L.M.R. LEVEL PART PLAN OF TOWER 2

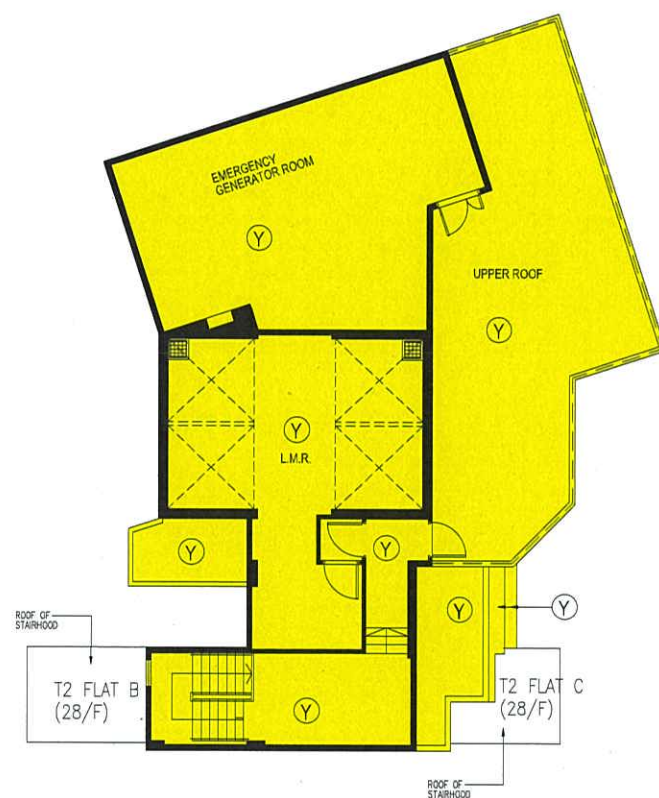

UPPER ROOF PLAN OF TOWER 2

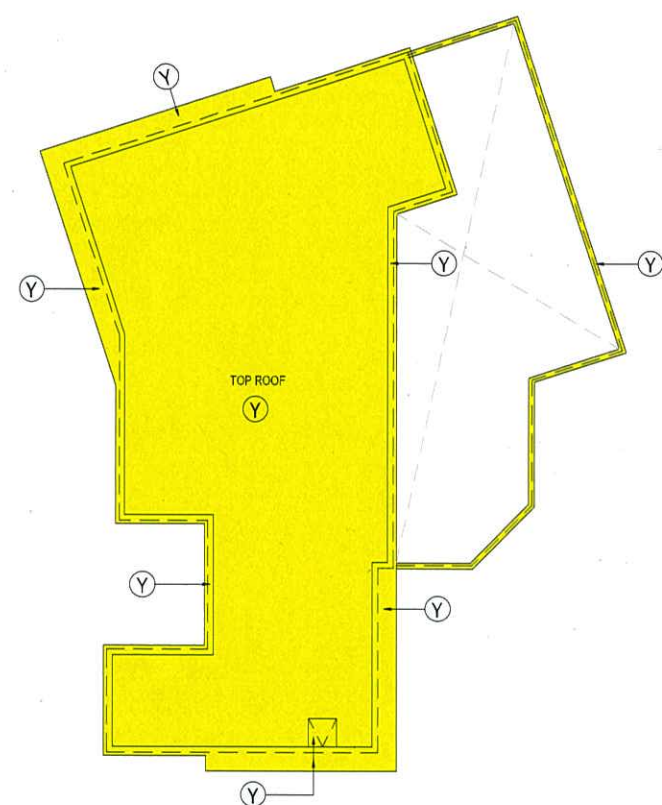

TOP ROOF PLAN OF TOWER 2

0m 1m 3m 5m

THIS PLAN IS FOR IDENTIFICATION PURPOSE ONLY



呂元祥建築師事務所

Project Title
**HO MAN TIN STATION
 PHASE II PROPERTY
 DEVELOPMENT AT KIL. NO.
 11264, HO MAN TIN, KOWLOON**

Drawing Title
 TOWER 2 FLOOR PLANS (4)

Project No. 17025KL.01
 Scale 1:200 Issue Date 14 JUL 2023
 Drawing No. A/DMC/13 (REV. E)

AP's Signature
 I HEREBY CERTIFY THE ACCURACY
 OF THIS PLAN.

CHEUNG Man-Ching, Anthony
 Authorized Person (Architect)
 14-07-2023



1/F PLAN OF TOWER 3

0m 1m 3m 5m

THIS PLAN IS FOR IDENTIFICATION PURPOSE ONLY

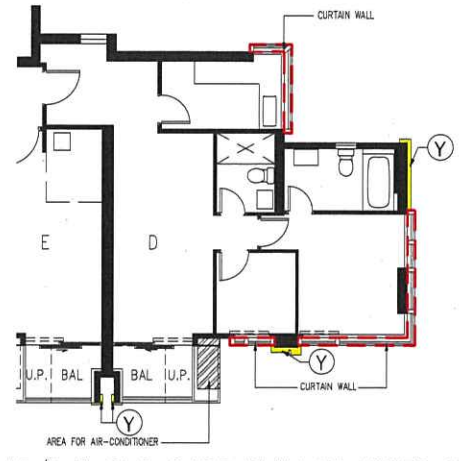

15/F FLAT D PART PLAN OF TOWER 3

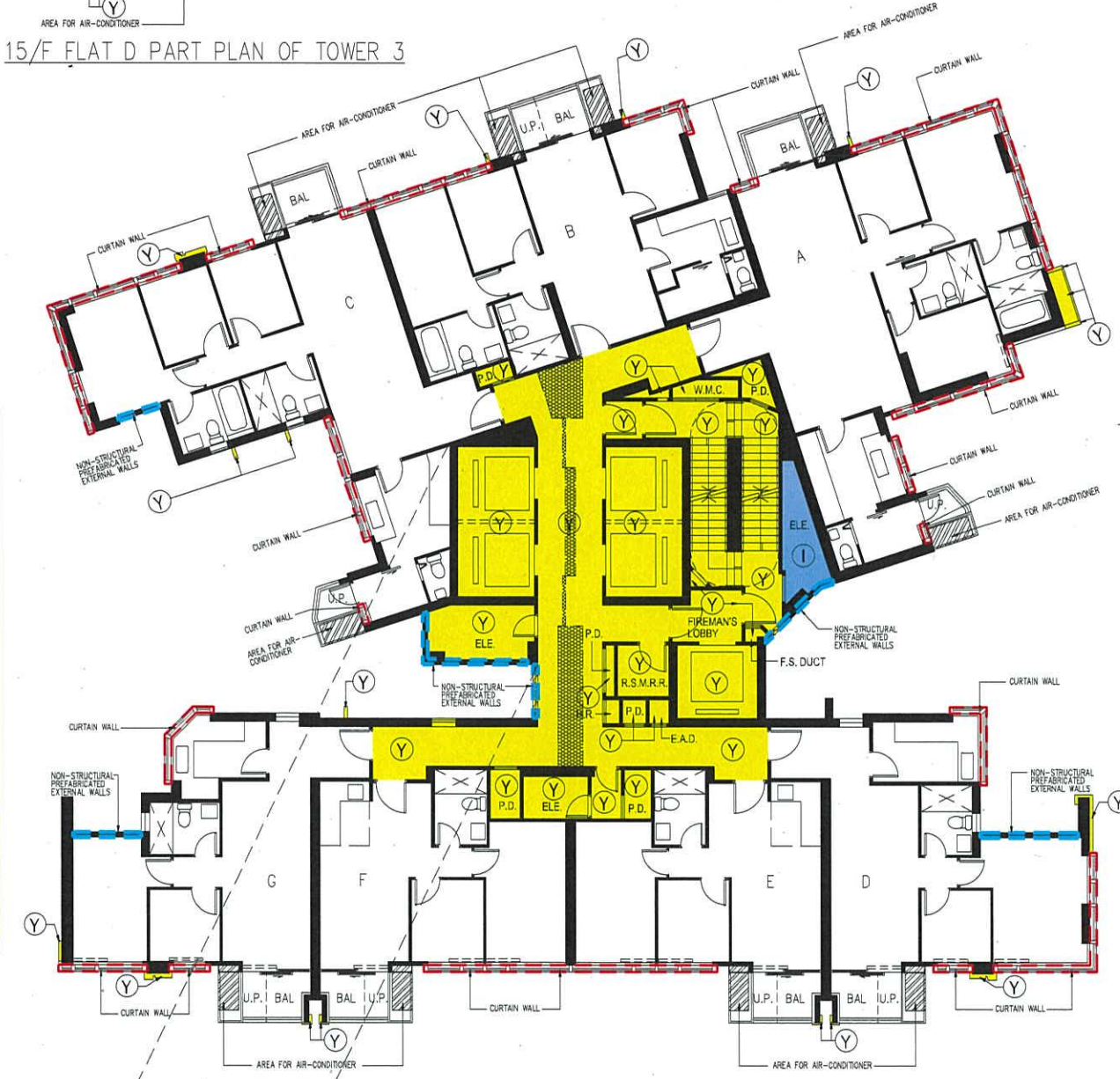

2/F-15/F PLAN OF TOWER 3
(11 STOREYS) (OMITTED 4/F, 13/F AND 14/F)

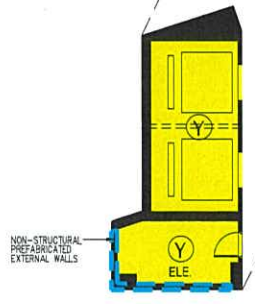

2/F PART PLAN OF TOWER 3

- LEGEND**
- Y PHASE II RESIDENTIAL COMMON AREAS
 - CURTAIN WALL
 - NON-STRUCTURAL PREFABRICATED EXTERNAL WALLS
 - AREA FOR AIR-CONDITIONER (AIR-CONDITIONING PLATFORM) (NON-ENCLOSED AREA)
 - PHASE II RESIDENTIAL COMMON AREAS (WIDER COMMON CORRIDOR)
 - I PHASE II COMMON AREAS
 - BAL = PHASE II BALCONY
 - U.P. = PHASE II UTILITY PLATFORM



呂元祥建築師事務所

Project Title
HO MAN TIN STATION
PHASE II PROPERTY
DEVELOPMENT AT KIL. NO.
11264, HO MAN TIN, KOWLOON

Drawing Title
TOWER 3 FLOOR PLANS (1)





Project No. 17025KL.01
Scale 1:200 Issue Date 14 JUL 2023
Drawing No. A/DMC/14 (REV. E)

AP's Signature
I HEREBY CERTIFY THE ACCURACY
OF THIS PLAN.

CHEUNG Man-Ching, Anthony
Authorized Person (Architect)
14-07-2023



LEGEND

-  PHASE II RESIDENTIAL COMMON AREAS
-  CURTAIN WALL
-  NON-STRUCTURAL PREFABRICATED EXTERNAL WALLS
-  AREA FOR AIR-CONDITIONER (AIR-CONDITIONING PLATFORM) (NON-ENCLOSED AREA)
-  PHASE II RESIDENTIAL COMMON AREAS (WIDER COMMON CORRIDOR)
-  PHASE II COMMON AREAS
- BAL = PHASE II BALCONY
- U.P. = PHASE II UTILITY PLATFORM

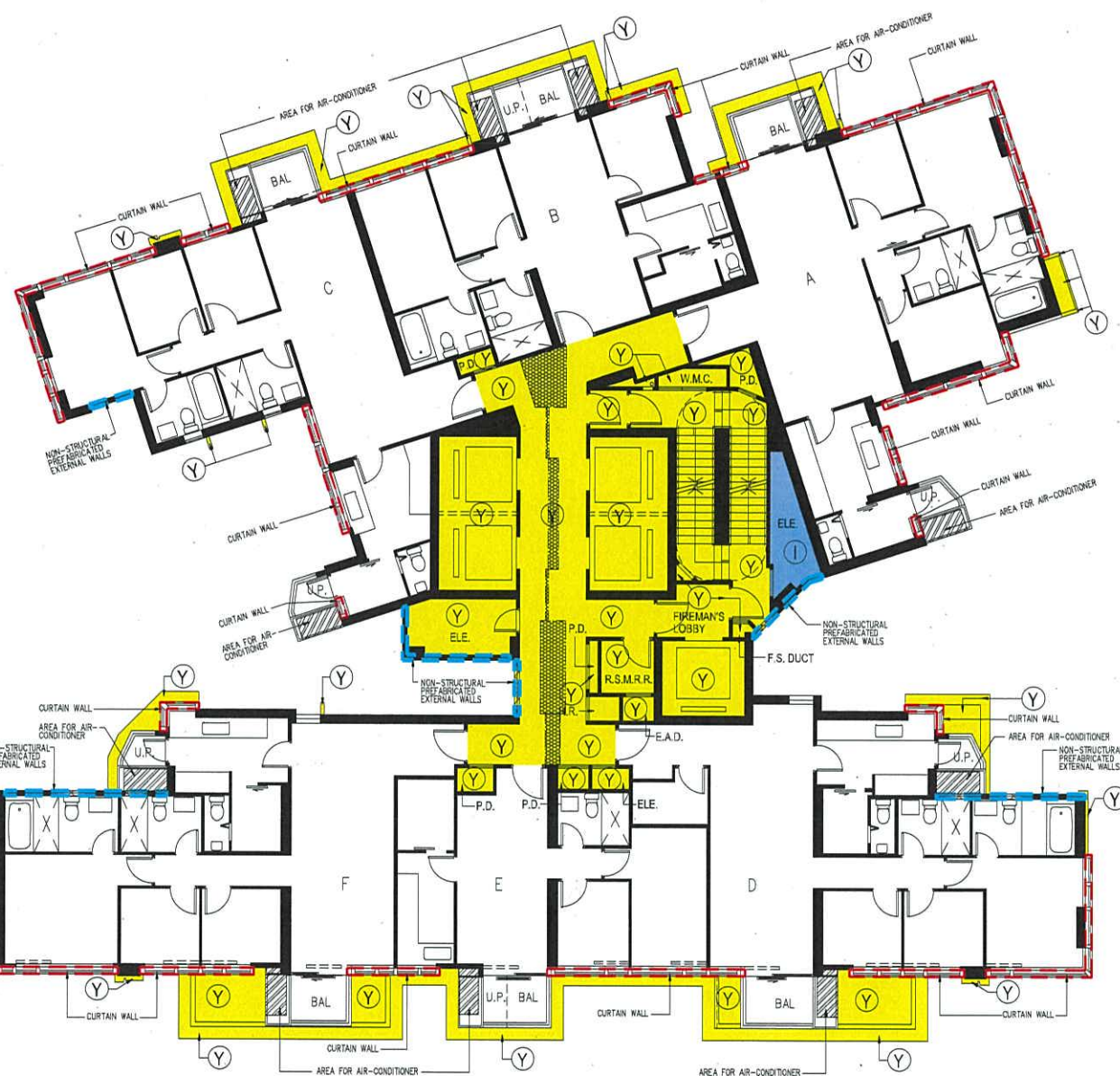

16/F-26/F PLAN OF TOWER 3
(10 STOREYS) (OMITTED 24/F)

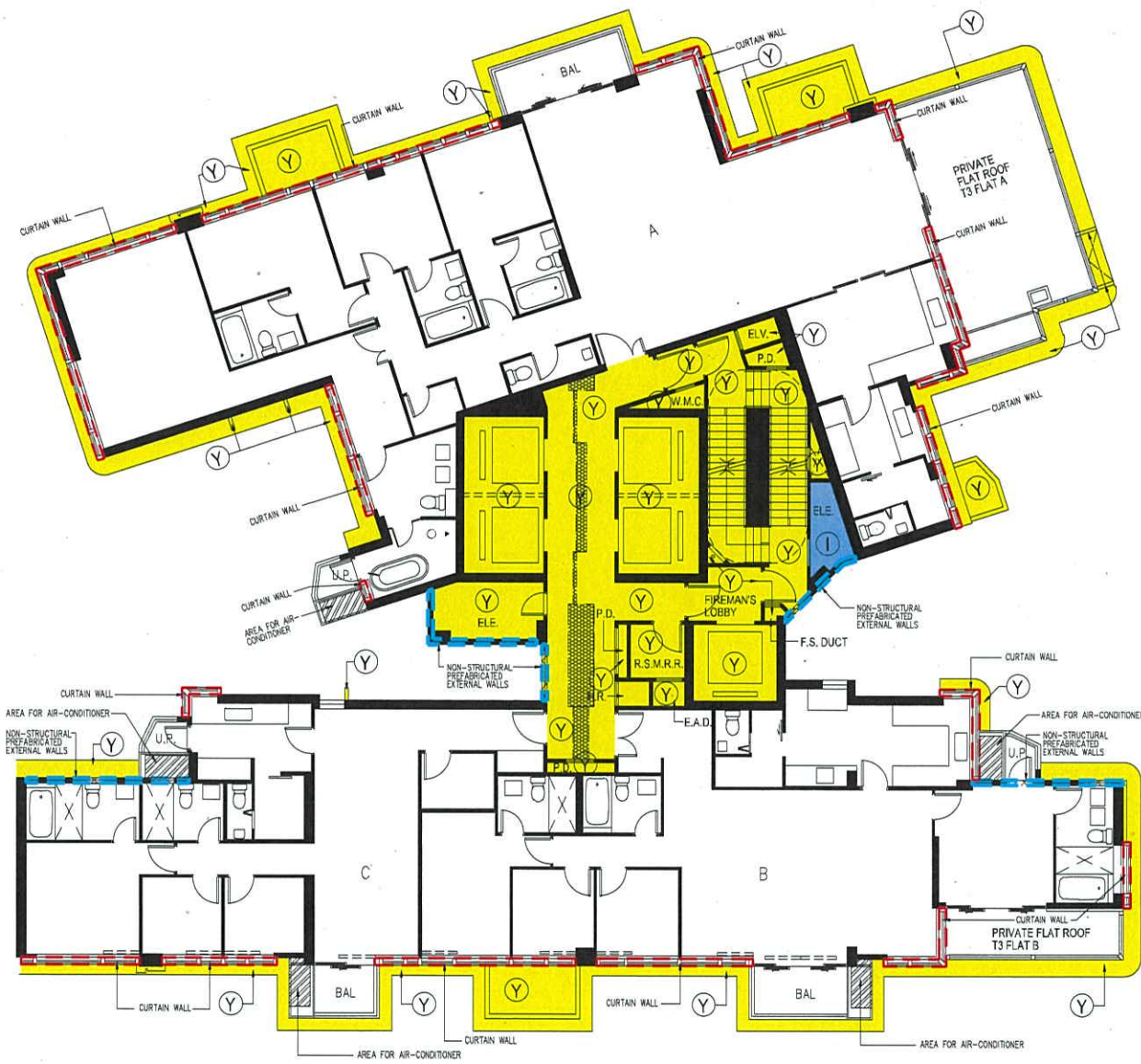

27/F PLAN OF TOWER 3

0m 1m 3m 5m

THIS PLAN IS FOR IDENTIFICATION PURPOSE ONLY



呂元祥建築師事務所

Project Title
HO MAN TIN STATION
PHASE II PROPERTY
DEVELOPMENT AT KIL. NO.
11264, HO MAN TIN, KOWLOON

Drawing Title
TOWER 3 FLOOR PLANS (2)

Project No. 17025KL.01
Scale 1:200 Issue Date 14 JUL 2023
Drawing No. A/DMC/15 (REV. E)

AP's Signature
I HEREBY CERTIFY THE ACCURACY
OF THIS PLAN.

CHEUNG Man-Ching, Anthony
Authorized Person (Architect)
14-07-2023



- LEGEND**
- Y PHASE II RESIDENTIAL COMMON AREAS
 - CURTAIN WALL
 - NON-STRUCTURAL PREFABRICATED EXTERNAL WALLS
 - AREA FOR AIR-CONDITIONER (AIR-CONDITIONING PLATFORM) (NON-ENCLOSED AREA)
 - PHASE II RESIDENTIAL COMMON AREAS (WIDER COMMON CORRIDOR)
 - 1 PHASE II COMMON AREAS
 - BAL = PHASE II BALCONY
 - U.P. = PHASE II UTILITY PLATFORM



28/F PLAN OF TOWER 3



ROOF PLAN OF TOWER 3

0m 1m 3m 5m

THIS PLAN IS FOR IDENTIFICATION PURPOSE ONLY



呂元祥建築師事務所

Project Title
**HO MAN TIN STATION
 PHASE II PROPERTY
 DEVELOPMENT AT KIL. NO.
 11264, HO MAN TIN, KOWLOON**

Drawing Title
 TOWER 3 FLOOR PLANS (3)

Project No. 17025KL.01
 Scale 1:200 Issue Date 14 JUL 2023
 Drawing No. A / DMC / 16 (REV. E)

AP's Signature
 I HEREBY CERTIFY THE ACCURACY
 OF THIS PLAN.

CHEUNG Ma-Ching, Anthony
 Authorized Person (Architect)
 14-07-2023



LEGEND

 PHASE II RESIDENTIAL COMMON AREAS

 PHASE II COMMON AREAS

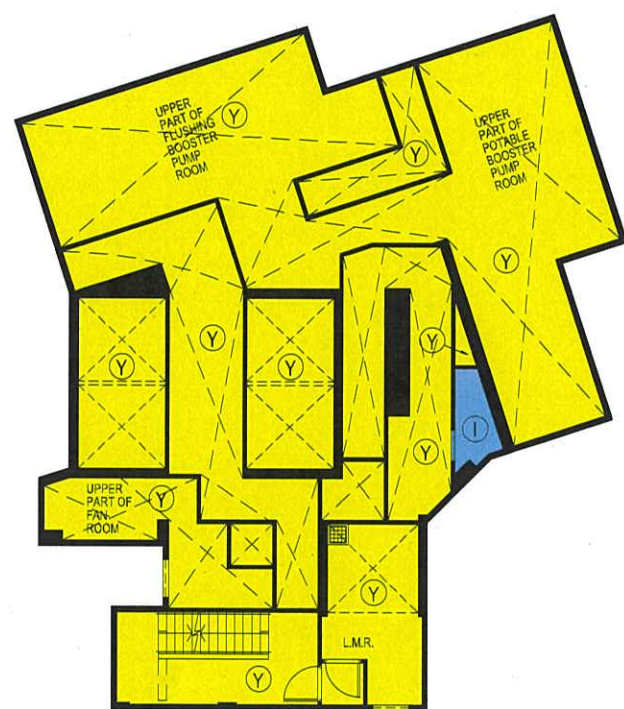

L.M.R. LEVEL PART PLAN OF TOWER 3

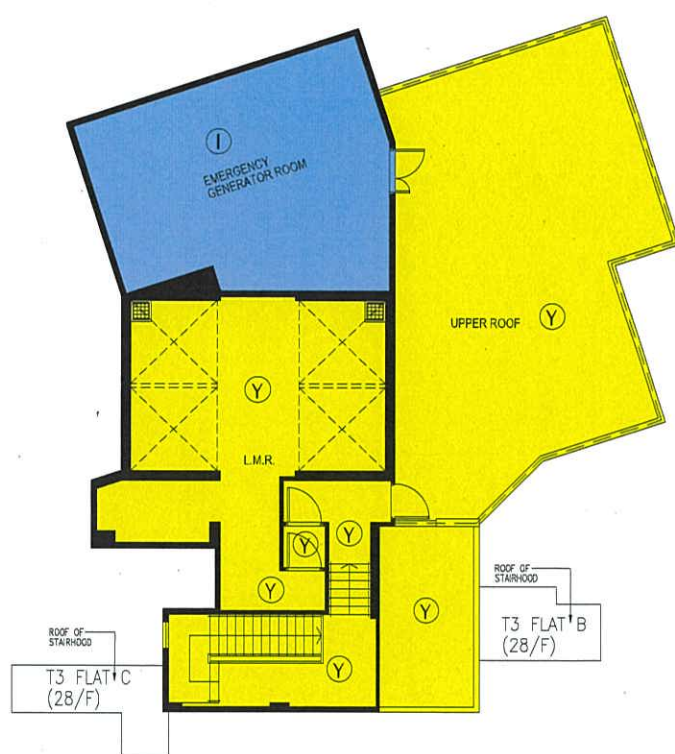

UPPER ROOF PLAN OF TOWER 3

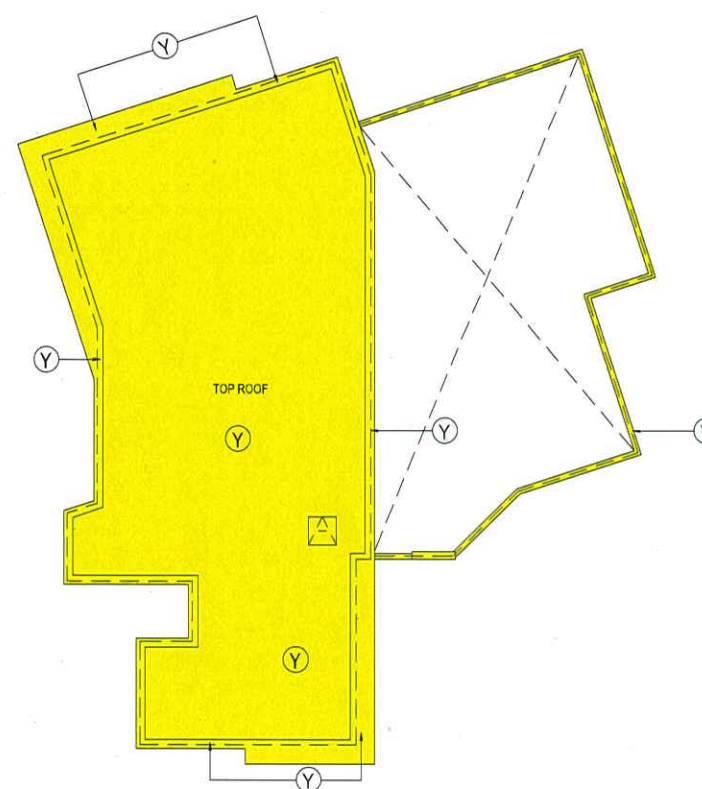

TOP ROOF PLAN OF TOWER 3

0m 1m 3m 5m

THIS PLAN IS FOR IDENTIFICATION PURPOSE ONLY

RONALD LU & PARTNERS

呂元祥建築師事務所

Project Title
**HO MAN TIN STATION
 PHASE II PROPERTY
 DEVELOPMENT AT KIL. NO.
 11264, HO MAN TIN, KOWLOON**

Drawing Title
 TOWER 3 FLOOR PLANS (4)

Project No. 17025KL.01
 Scale 1:200 Issue Date 14 JUL 2023
 Drawing No. A/DMC/17 (REV. E)

AP's Signature
 I HEREBY CERTIFY THE ACCURACY
 OF THIS PLAN.

CHEUNG Man-Ching, Anthony
 Authorized Person (Architect)
 14-07-2023

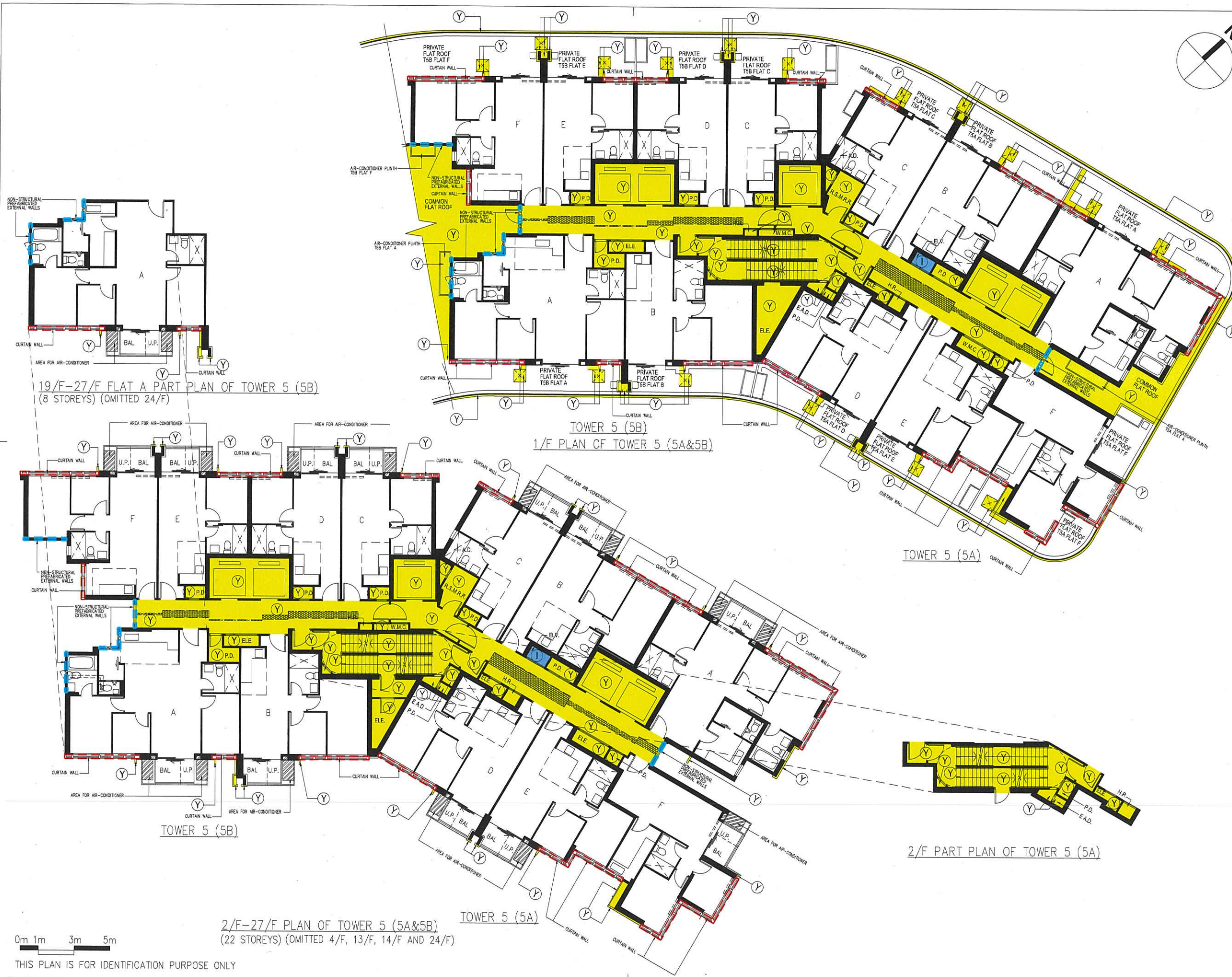

- LEGEND**
- Y PHASE II RESIDENTIAL COMMON AREAS
 - CURTAIN WALL
 - NON-STRUCTURAL PREFABRICATED EXTERNAL WALLS
 - AREA FOR AIR-CONDITIONER (AIR-CONDITIONING PLATFORM) (NON-ENCLOSED AREA)
 - PHASE II RESIDENTIAL COMMON AREAS (WIDER COMMON CORRIDOR)
 - 1 PHASE II COMMON AREAS
 - BAL = PHASE II BALCONY
 - U.P. = PHASE II UTILITY PLATFORM

Latest Rev. Date to be
20 Oct 2023

RONALD LU & PARTNERS
呂元祥建築師事務所

Project Title
HO MAN TIN STATION
PHASE II PROPERTY
DEVELOPMENT AT KIL. NO.
11264, HO MAN TIN, KOWLOON

Drawing Title
TOWER 5 FLOOR PLANS (1)

Project No. 17025KL.01
Scale 1:200 Issue Date 20 OCT 2023
Drawing No. A/DMC/18 (REV. E)

AP's Signature
I HEREBY CERTIFY THE ACCURACY
OF THIS PLAN.

CHEUNG Man Ching Anthony
Authorized Person (Architect)
20-10-2023

0m 1m 3m 5m

THIS PLAN IS FOR IDENTIFICATION PURPOSE ONLY

2/F-27/F PLAN OF TOWER 5 (5A&5B)
(22 STOREYS) (OMITTED 4/F, 13/F, 14/F AND 24/F)

19/F-27/F FLAT A PART PLAN OF TOWER 5 (5B)
(8 STOREYS) (OMITTED 24/F)

TOWER 5 (5B)
1/F PLAN OF TOWER 5 (5A&5B)

TOWER 5 (5B)

TOWER 5 (5A)

2/F PART PLAN OF TOWER 5 (5A)



TOWER 5 (5B)
28/F PLAN OF TOWER 5 (5A&5B)

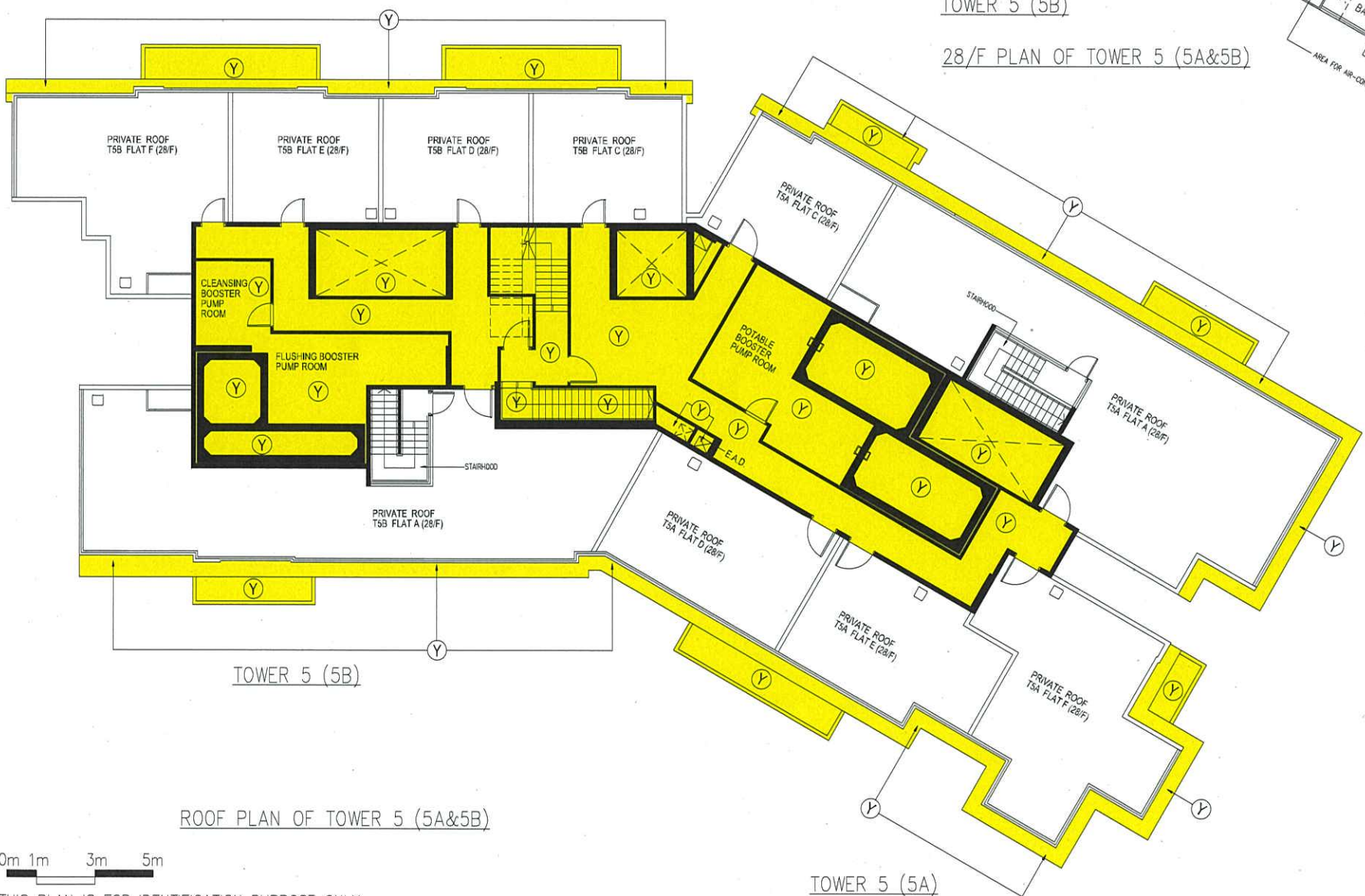

ROOF PLAN OF TOWER 5 (5A&5B)

0m 1m 3m 5m

THIS PLAN IS FOR IDENTIFICATION PURPOSE ONLY



- LEGEND**
- Y PHASE II RESIDENTIAL COMMON AREAS
 - CURTAIN WALL
 - NON-STRUCTURAL PREFABRICATED EXTERNAL WALLS
 - AREA FOR AIR-CONDITIONER (AIR-CONDITIONING PLATFORM) (NON-ENCLOSED AREA)
 - PHASE II RESIDENTIAL COMMON AREAS (WIDER COMMON CORRIDOR)
 - I PHASE II COMMON AREAS
 - BAL = PHASE II BALCONY
 - U.P. = PHASE II UTILITY PLATFORM



呂元祥建築師事務所

Project Title
HO MAN TIN STATION
PHASE II PROPERTY
DEVELOPMENT AT KIL. NO.
11264, HO MAN TIN, KOWLOON

Drawing Title
TOWER 5 FLOOR PLANS (2)

Project No. 17025KL.01
Scale 1:200 Issue Date 14 JUL 2023
Drawing No. A/DMC/19 (REV. E)

AP's Signature
I HEREBY CERTIFY THE ACCURACY
OF THIS PLAN.

CHEUNG Man-Ching, Anthony
Authorized Person (Architect)
14-07-2023

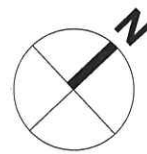

- LEGEND**
- Y PHASE II RESIDENTIAL COMMON AREAS
 - 1 PHASE II COMMON AREAS

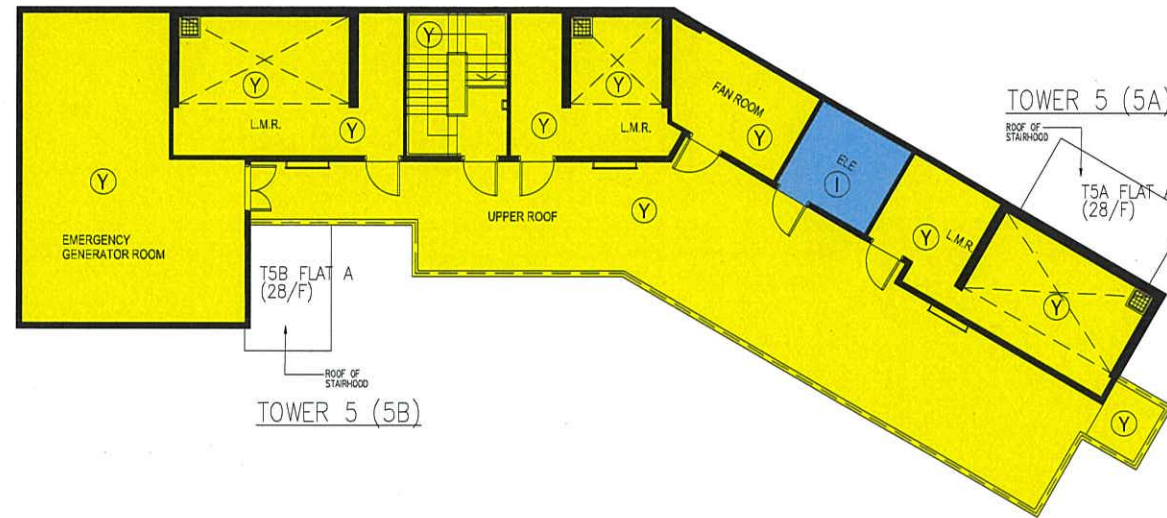

UPPER ROOF PLAN OF TOWER 5 (5A&5B)

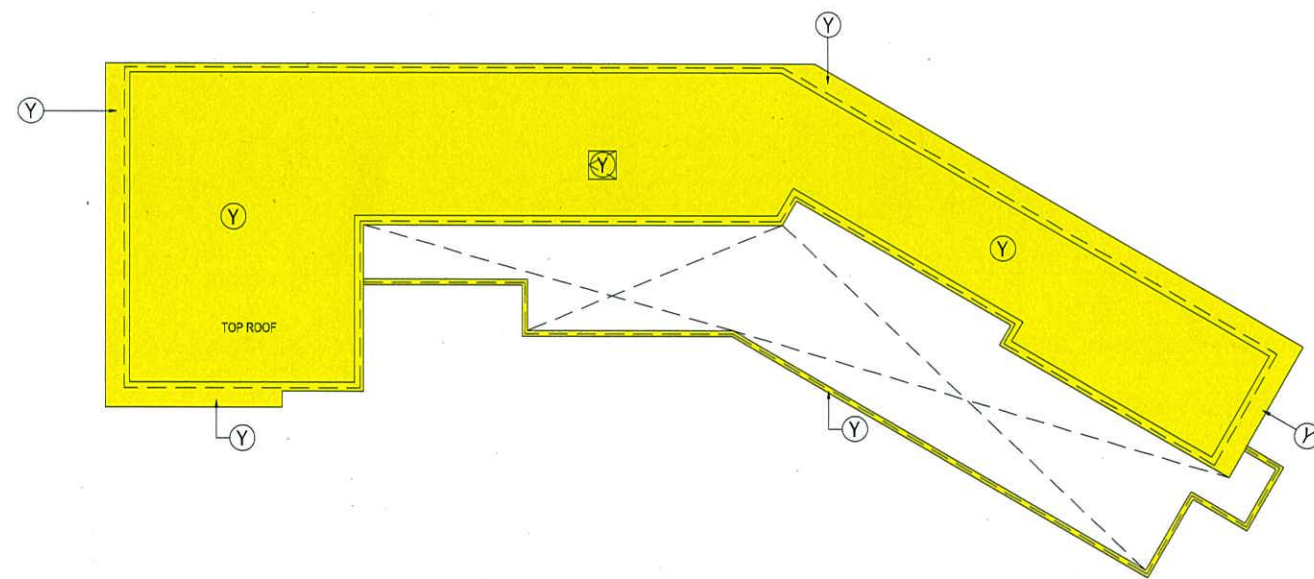

TOP ROOF PLAN OF TOWER 5 (5A&5B)

0m 1m 3m 5m

THIS PLAN IS FOR IDENTIFICATION PURPOSE ONLY



呂元祥建築師事務所

Project Title
**HO MAN TIN STATION
 PHASE II PROPERTY
 DEVELOPMENT AT KIL. NO.
 11264, HO MAN TIN, KOWLOON**

Drawing Title
 TOWER 5 FLOOR PLANS (3)

Project No. 17025KL.01
 Scale 1:200 Issue Date 14 JUL 2023
 Drawing No. A/DMC/20 (REV. E)

AP's Signature
 I HEREBY CERTIFY THE ACCURACY
 OF THIS PLAN.

CHEUNG Man Ching, Anthony
 Authorized Person (Architect)
 14-07-2023



- LEGEND**
- Y PHASE II RESIDENTIAL COMMON AREAS
 - CURTAIN WALL
 - NON-STRUCTURAL PREFABRICATED EXTERNAL WALLS
 - AREA FOR AIR-CONDITIONER (AIR-CONDITIONING PLATFORM) (NON-ENCLOSED AREA)
 - PHASE II RESIDENTIAL COMMON AREAS (WIDER COMMON CORRIDOR)
 - 1 PHASE II COMMON AREAS
 - BAL = PHASE II BALCONY
 - U.P. = PHASE II UTILITY PLATFORM

22/F-27/F FLAT F PART PLAN OF TOWER 6 (6B)
(5 STOREYS) (OMITTED 24/F)

1/F PLAN OF TOWER 6 (6A&6B)

TOWER 6 (6A)

TOWER 6 (6B)

TOWER 6 (6B)

TOWER 6 (6A)

19/F-27/F FLAT A PART PLAN OF TOWER 6 (6B)
(8 STOREYS) (OMITTED 24/F)

2/F-27/F PLAN OF TOWER 6 (6A&6B)
(22 STOREYS) (OMITTED 4/F, 13/F, 14/F AND 24/F)

0m 1m 3m 5m

THIS PLAN IS FOR IDENTIFICATION PURPOSE ONLY



呂元祥建築師事務所

Project Title
HO MAN TIN STATION
PHASE II PROPERTY
DEVELOPMENT AT KIL. NO.
11264, HO MAN TIN, KOWLOON

Drawing Title
TOWER 6 FLOOR PLANS (1)

Project No. 17025KL.01
Scale 1:200 Issue Date 20 OCT 2023
Drawing No. A/DMC/21 (REV. E)

AP's Signature
I HEREBY CERTIFY THE ACCURACY
OF THIS PLAN.

CHEUNG Man Ching Anthony
Authorized Person (Architect)
20-10-2023



LEGEND

- Y PHASE II RESIDENTIAL COMMON AREAS
- CURTAIN WALL
- NON-STRUCTURAL PREFABRICATED EXTERNAL WALLS
- AREA FOR AIR-CONDITIONER (AIR-CONDITIONING PLATFORM) (NON-ENCLOSED AREA)
- PHASE II RESIDENTIAL COMMON AREAS (WIDER COMMON CORRIDOR)
- I PHASE II COMMON AREAS
- BAL = PHASE II BALCONY
- U.P. = PHASE II UTILITY PLATFORM



呂元祥建築師事務所

Project Title
**HO MAN TIN STATION
 PHASE II PROPERTY
 DEVELOPMENT AT KIL. NO.
 11264, HO MAN TIN, KOWLOON**

Drawing Title
TOWER 6 FLOOR PLANS (2)

Project No. 17025KL.01
 Scale 1:200 Issue Date 14 JUL 2023
 Drawing No. A/DMC/22 (REV. E)

AP's Signature
 I HEREBY CERTIFY THE ACCURACY
 OF THIS PLAN.

CHEUNG Man Ching, Anthony
 Authorized Person (Architect)
 14-07-2023

0m 1m 3m 5m

THIS PLAN IS FOR IDENTIFICATION PURPOSE ONLY

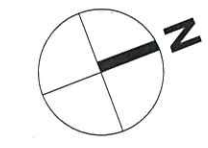

- LEGEND**
- Y PHASE II RESIDENTIAL COMMON AREAS
 - I PHASE II COMMON AREAS

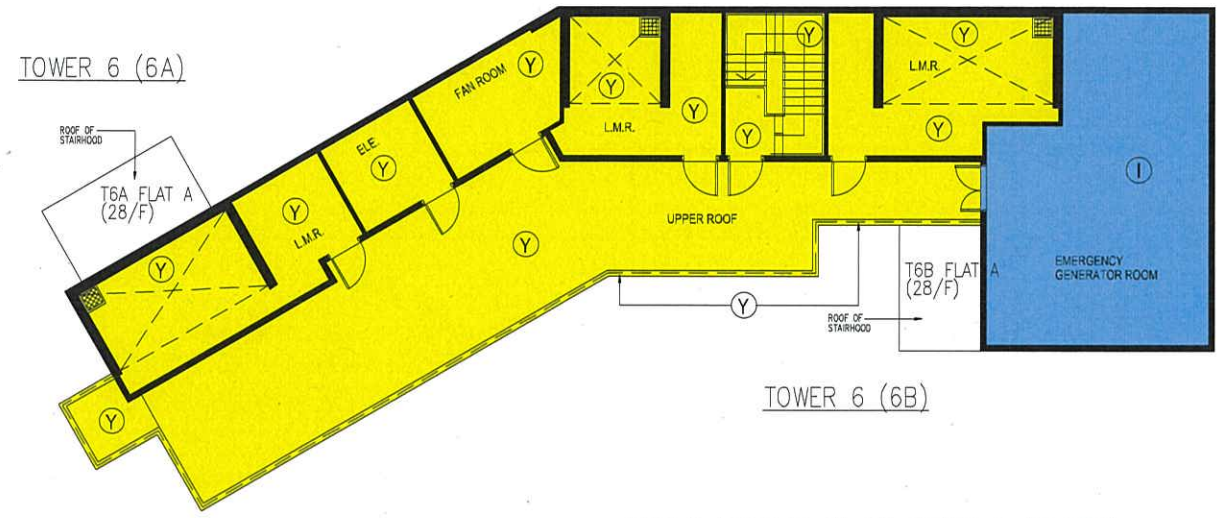

UPPER ROOF PLAN OF TOWER 6 (6A&6B)

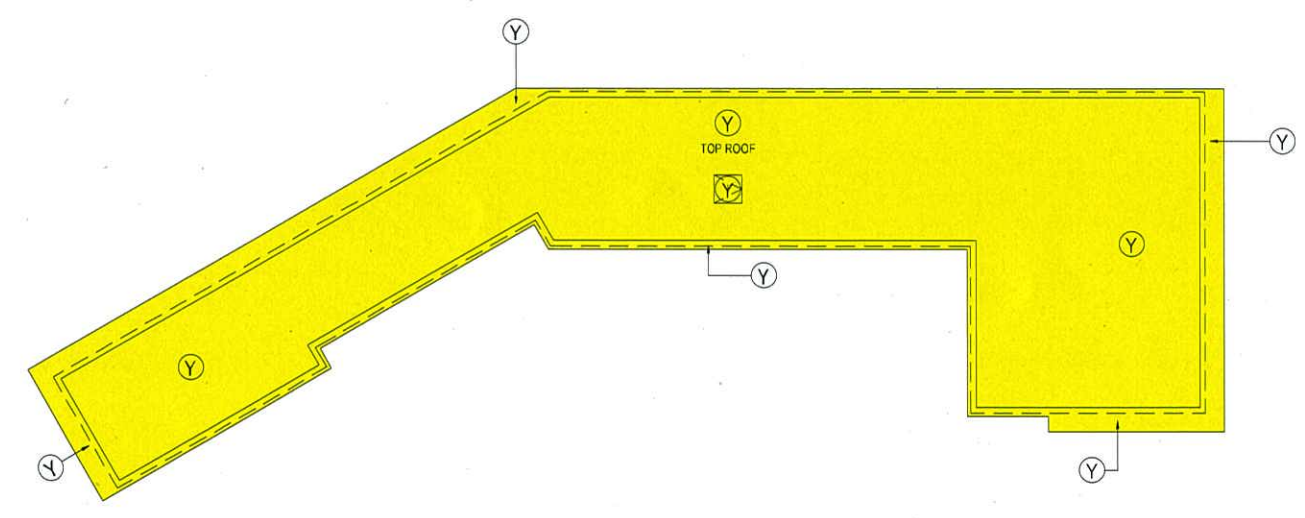

TOP ROOF PLAN OF TOWER 6 (6A&6B)

0m 1m 3m 5m

THIS PLAN IS FOR IDENTIFICATION PURPOSE ONLY



呂元祥建築師事務所

Project Title
**HO MAN TIN STATION
 PHASE II PROPERTY
 DEVELOPMENT AT KIL. NO.
 11264, HO MAN TIN, KOWLOON**

Drawing Title
 TOWER 6 FLOOR PLANS (3)

Project No. 17025KL.01
 Scale 1:200 Issue Date 14 JUL 2023
 Drawing No. A/DMC/23 (REV. E)

AP's Signature
 I HEREBY CERTIFY THE ACCURACY
 OF THIS PLAN.

CHEUNG Man-Ching, Anthony
 Authorized Person (Architect)
 14-07-2023



LEGEND

— — — — —
SITE BOUNDARY

□ □ □ □
PHASE IIA
(CROSS-HATCHED PINK)

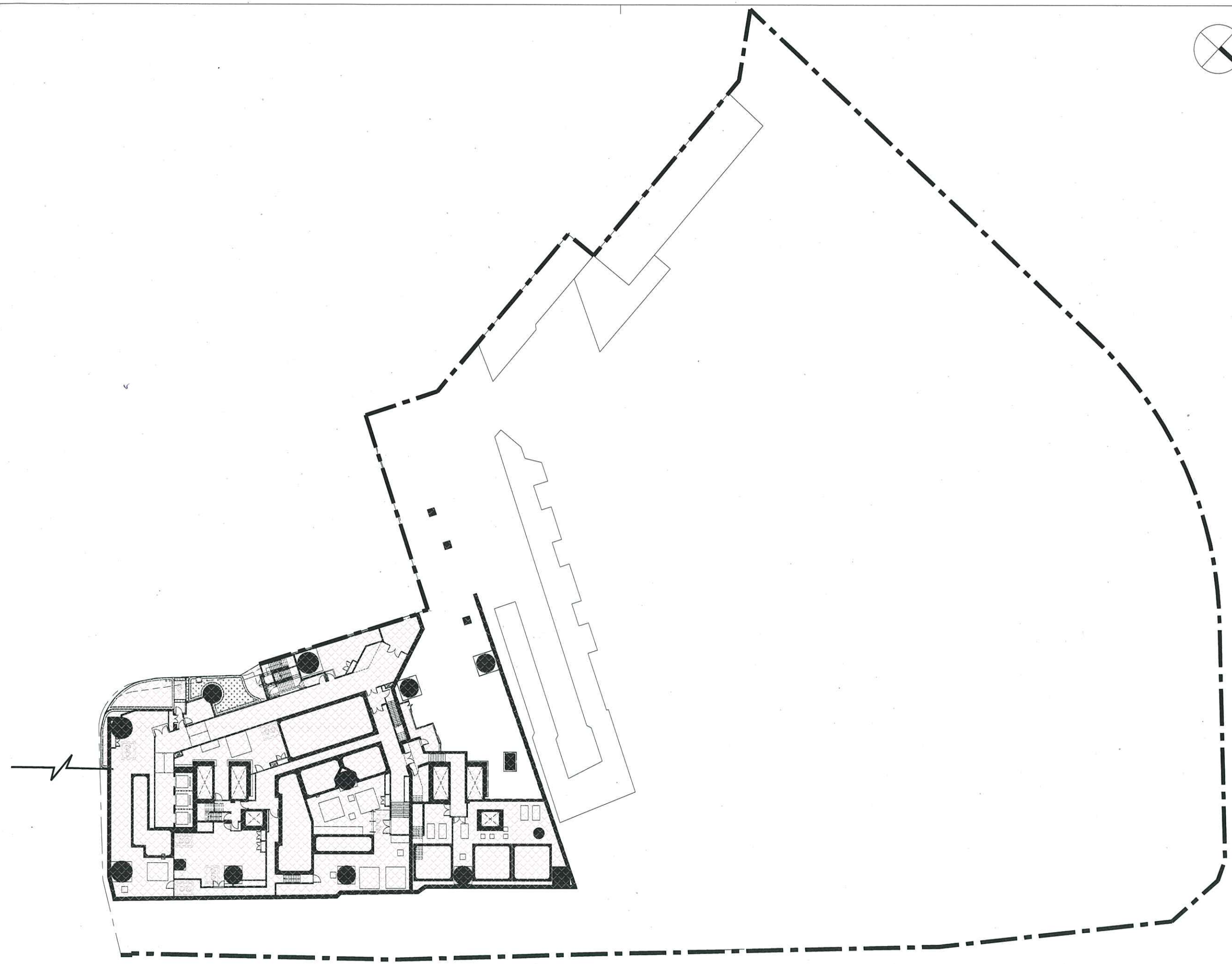

0m 5m 15m 30m

THIS PLAN IS FOR IDENTIFICATION PURPOSE ONLY



呂元祥建築師事務所

Project Title
**HO MAN TIN STATION
PHASE II PROPERTY
DEVELOPMENT AT KIL. NO.
11264, HO MAN TIN, KOWLOON**

Drawing Title
**PHASING PLAN –
LOWER GROUND 4 LEVEL +26.3**

Project No. 17025KL.01
Scale 1:500 Issue Date 14 JUL 2023
Drawing No. A / DMC / P02 (REV. E)

AP's Signature
I HEREBY CERTIFY THE ACCURACY
OF THIS PLAN.

CHEUNG Man-Cing, Anthony
Authorized Person (Architect)
14-07-2023



- LEGEND**
-  SITE BOUNDARY
 -  PHASE IIA
(CROSS-HATCHED PINK)

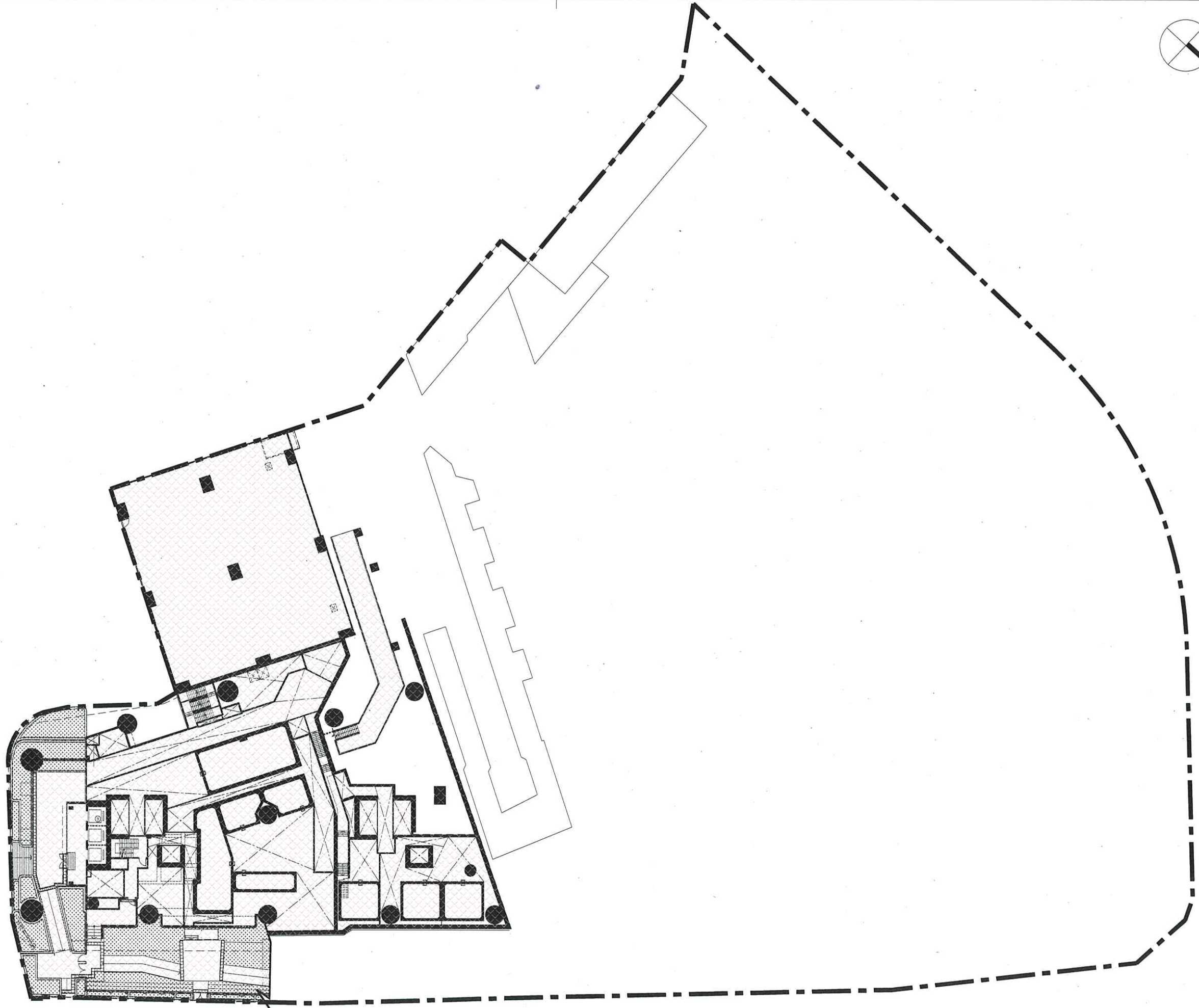

0m 5m 15m 30m

THIS PLAN IS FOR IDENTIFICATION PURPOSE ONLY



呂元祥建築師事務所

Project Title
**HO MAN TIN STATION
 PHASE II PROPERTY
 DEVELOPMENT AT KIL. NO.
 11264, HO MAN TIN, KOWLOON**

Drawing Title
 PHASING PLAN –
 LOWER GROUND 3 LEVEL +30.8

Project No. 17025KL.01
 Scale 1:500 Issue Date 14 JUL 2023
 Drawing No. A / DMC / P03 (REV. E)

AP's Signature
 I HEREBY CERTIFY THE ACCURACY
 OF THIS PLAN.

CHEUNG Man-Ching, Anthony
 Authorized Person (Architect)
 14-07-2023



- LEGEND**
- — — — — SITE BOUNDARY
 - ▨ PHASE IIA
(CROSS-HATCHED PINK)
 - ▩ PHASE IIB
(CROSS-HATCHED GREEN)

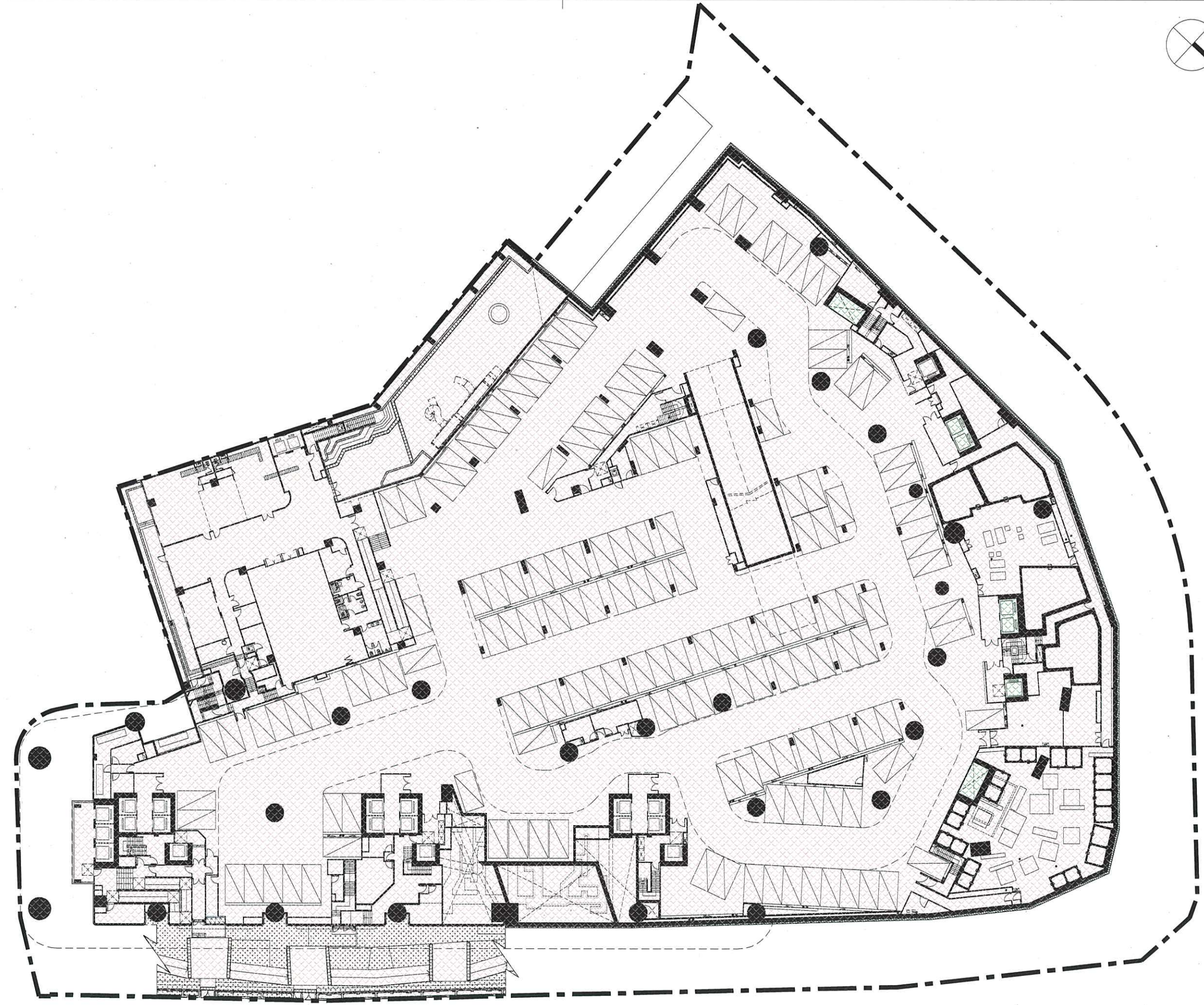

0m 5m 15m 30m
THIS PLAN IS FOR IDENTIFICATION PURPOSE ONLY



呂元祥建築師事務所

Project Title
HO MAN TIN STATION
PHASE II PROPERTY
DEVELOPMENT AT KIL. NO.
11264, HO MAN TIN, KOWLOON

Drawing Title
PHASING PLAN -
LOWER GROUND 2 LEVEL +33.05



Project No. 17025KL.01
Scale 1:500 Issue Date 14 JUL 2023
Drawing No. A / DMC / P04 (REV. E)

AP's Signature
I HEREBY CERTIFY THE ACCURACY
OF THIS PLAN.

CHEUNG Man Ching, Anthony
Authorized Person (Architect)
14-07-2023



LEGEND

-  SITE BOUNDARY
-  PHASE IIA
(CROSS-HATCHED PINK)
-  PHASE IIB
(CROSS-HATCHED GREEN)

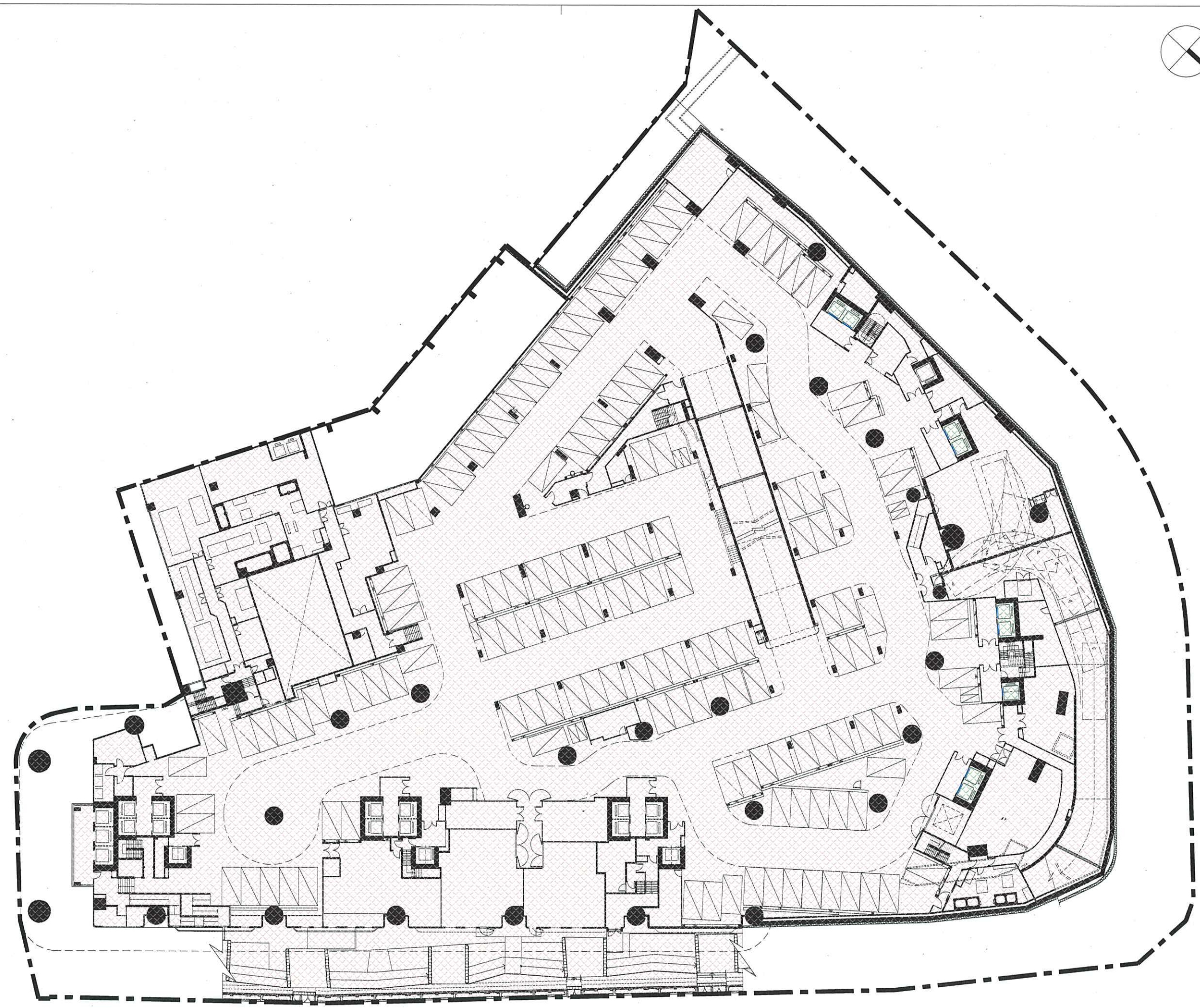

呂元祥建築師事務所

Project Title
**HO MAN TIN STATION
 PHASE II PROPERTY
 DEVELOPMENT AT KIL. NO.
 11264, HO MAN TIN, KOWLOON**

Drawing Title
 PHASING PLAN –
 LOWER GROUND 1 LEVEL+36.75

Project No. 17025KL.01
 Scale 1:500 Issue Date 14 JUL 2023
 Drawing No. A / DMC / P05 (REV. E)

AP's Signature
 I HEREBY CERTIFY THE ACCURACY
 OF THIS PLAN.

CHEUNG Man-Ching, Anthony
 Authorized Person (Architect)
 14-07-2023

0m 5m 15m 30m

THIS PLAN IS FOR IDENTIFICATION PURPOSE ONLY

UNEXCAVATED

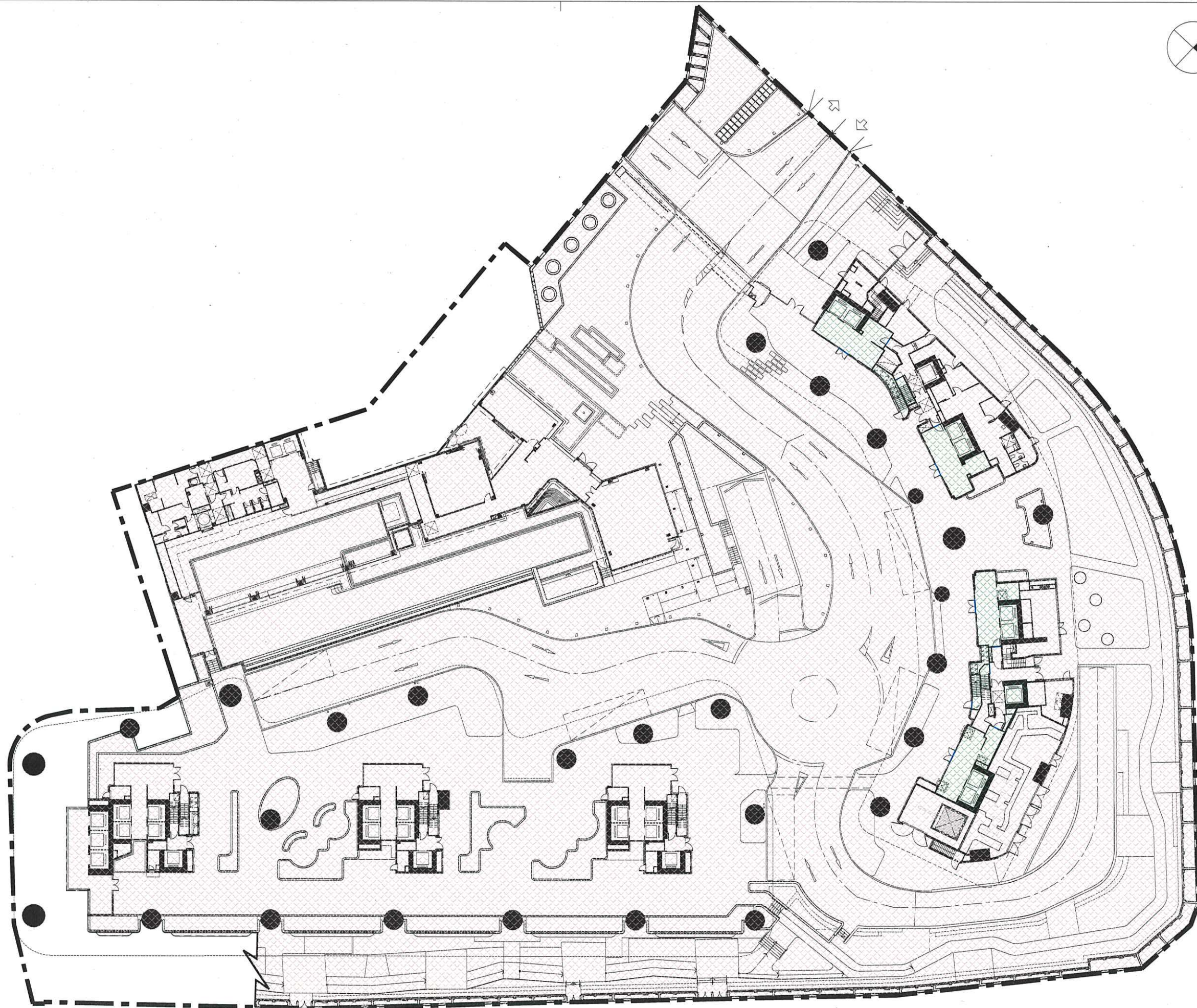

- LEGEND**
- — — — — SITE BOUNDARY
 - (CROSS-HATCHED PINK) PHASE IIA (CROSS-HATCHED PINK)
 - (CROSS-HATCHED GREEN) PHASE IIB (CROSS-HATCHED GREEN)



呂元祥建築師事務所

Project Title
**HO MAN TIN STATION
 PHASE II PROPERTY
 DEVELOPMENT AT KIL. NO.
 11264, HO MAN TIN, KOWLOON**

Drawing Title
 PHASING PLAN –
 GROUND LEVEL +42.00

Project No. 17025KL.01
 Scale 1:500 Issue Date 14 JUL 2023
 Drawing No. A / DMC / P06 (REV. E)

AP's Signature
 I HEREBY CERTIFY THE ACCURACY
 OF THIS PLAN.

CHEUNG Man Ching, Anthony
 Authorized Person (Architect)
 14-07-2023

0m 5m 15m 30m

THIS PLAN IS FOR IDENTIFICATION PURPOSE ONLY

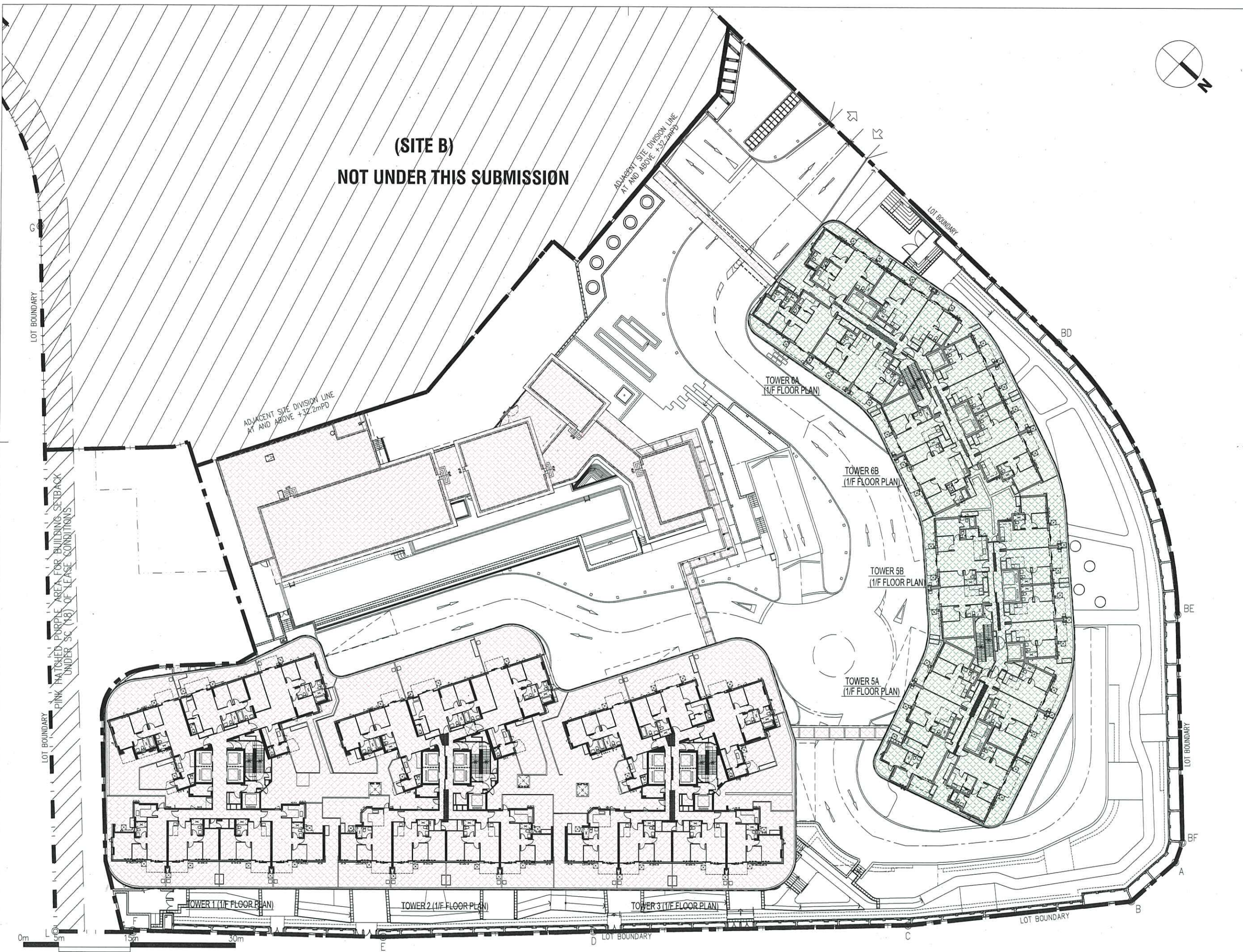

LEGEND

- SITE BOUNDARY
- ▨ PHASE IIA
(CROSS-HATCHED PINK)
- ▩ PHASE IIB
(CROSS-HATCHED GREEN)

**(SITE B)
NOT UNDER THIS SUBMISSION**



呂元祥建築師事務所

Project Title
**HO MAN TIN STATION
 PHASE II PROPERTY
 DEVELOPMENT AT KIL. NO.
 11264, HO MAN TIN, KOWLOON**

Drawing Title
**PHASING PLAN –
 1ST LEVEL +50.20**

Project No. 17025KL.01
 Scale 1:500 Issue Date 14 JUL 2023
 Drawing No. A / DMC / P07 (REV. E)

AP's Signature
 I HEREBY CERTIFY THE ACCURACY
 OF THIS PLAN.

CHEUNG Man-Ching, Anthony
 Authorized Person (Architect)
 14-07-2023

THIS PLAN IS FOR IDENTIFICATION PURPOSE ONLY

- LEGEND**
- — — — — SITE BOUNDARY
 - ▨ PHASE IIA (CROSS-HATCHED PINK)
 - ▨ PHASE IIB (CROSS-HATCHED GREEN)



呂元祥建築師事務所

Project Title
**HO MAN TIN STATION
 PHASE II PROPERTY
 DEVELOPMENT AT KIL. NO.
 11264, HO MAN TIN, KOWLOON**

Drawing Title
 PHASING PLAN -
 2/F - 15/F FLOOR PLAN

Project No. 17025KL.01
 Scale 1:500 Issue Date 14 JUL 2023
 Drawing No. A / DMC / P08 (REV. E)

AP's Signature
 I HEREBY CERTIFY THE ACCURACY
 OF THIS PLAN

CHEUNG Man-Ching, Anthony
 Authorized Person (Architect)
 14-07-2023

0m 5m 15m 30m

THIS PLAN IS FOR IDENTIFICATION PURPOSE ONLY

- LEGEND**
- — — — — SITE BOUNDARY
 - ▨ PHASE IIA
(CROSS-HATCHED PINK)
 - ▩ PHASE IIB
(CROSS-HATCHED GREEN)



呂元祥建築師事務所

Project Title
**HO MAN TIN STATION
 PHASE II PROPERTY
 DEVELOPMENT AT KIL. NO.
 11264, HO MAN TIN, KOWLOON**

Drawing Title
 PHASING PLAN -
 16/F - 26/F FLOOR PLAN

Project No. 17025KL.01
 Scale 1:500 Issue Date 14 JUL 2023
 Drawing No. A / DMC / P09 (REV. E)

AP's Signature
 I HEREBY CERTIFY THE ACCURACY
 OF THIS PLAN.

CHEUNG Man-Ching, Anthony
 Authorized Person (Architect)
 14-07-2023

0m 5m 15m 30m

THIS PLAN IS FOR IDENTIFICATION PURPOSE ONLY

- LEGEND**
- — — — — SITE BOUNDARY
 - ▨ PHASE IIA
(CROSS-HATCHED PINK)
 - ▨ PHASE IIB
(CROSS-HATCHED GREEN)



TOWER 6 (6A)
(27/F FLOOR PLAN)

TOWER 6 (6B)
(27/F FLOOR PLAN)

TOWER 5 (5B)
(27/F FLOOR PLAN)

TOWER 5 (5A)
(27/F FLOOR PLAN)

TOWER 1 (27/F FLOOR PLAN)

TOWER 2 (27/F FLOOR PLAN)

TOWER 3 (27/F FLOOR PLAN)

0m 5m 15m 30m

THIS PLAN IS FOR IDENTIFICATION PURPOSE ONLY



呂元祥建築師事務所

Project Title
HO MAN TIN STATION
PHASE II PROPERTY
DEVELOPMENT AT KIL. NO.
11264, HO MAN TIN, KOWLOON

Drawing Title
PHASING PLAN –
27/F FLOOR PLAN

Project No. 17025KL.01
Scale 1:500 Issue Date 14 JUL 2023
Drawing No. A / DMC / P10 (REV. E)

AP's Signature
I HEREBY CERTIFY THE ACCURACY
OF THIS PLAN.

CHEUNG Man Ching, Anthony
Authorized Person (Architect)
14-07-2023

- LEGEND**
- — — — — SITE BOUNDARY
 - ▨ PHASE IIA
(CROSS-HATCHED PINK)
 - ▩ PHASE IIB
(CROSS-HATCHED GREEN)



TOWER 1 (28/F FLOOR PLAN)

TOWER 2 (28/F FLOOR PLAN)

TOWER 3 (28/F FLOOR PLAN)

TOWER 5 (5A)
(28/F FLOOR PLAN)

TOWER 5 (5B)
(28/F FLOOR PLAN)

TOWER 6 (6B)
(28/F FLOOR PLAN)

TOWER 6 (6A)
(28/F FLOOR PLAN)

0m 5m 15m 30m

THIS PLAN IS FOR IDENTIFICATION PURPOSE ONLY



呂元祥建築師事務所

Project Title
**HO MAN TIN STATION
 PHASE II PROPERTY
 DEVELOPMENT AT KIL. NO.
 11264, HO MAN TIN, KOWLOON**

Drawing Title
 PHASING PLAN –
 28/F FLOOR PLAN

Project No. 17025KL.01
 Scale 1:500 Issue Date 14 JUL 2023
 Drawing No. A / DMC / P11 (REV. E)

AP's Signature
 I HEREBY CERTIFY THE ACCURACY
 OF THIS PLAN.

CHEUNG Man-Ching, Anthony
 Authorized Person (Architect)
 14-07-2023

- LEGEND**
- — — — — SITE BOUNDARY
 - ▨ PHASE IIA
(CROSS-HATCHED PINK)
 - ▨ PHASE IIB
(CROSS-HATCHED GREEN)



TOWER 1 (ROOF PLAN)

TOWER 2 (ROOF PLAN)

TOWER 3 (ROOF PLAN)

TOWER 6 (6A&6B)
(ROOF PLAN)

TOWER 5 (5A&5B)
(ROOF PLAN)

0m 5m 15m 30m

THIS PLAN IS FOR IDENTIFICATION PURPOSE ONLY



呂元祥建築師事務所

Project Title
**HO MAN TIN STATION
 PHASE II PROPERTY
 DEVELOPMENT AT KIL. NO.
 11264, HO MAN TIN, KOWLOON**

Drawing Title
**PHASING PLAN –
 ROOF PLAN**

Project No. 17025KL.01
 Scale 1:500 Issue Date 14 JUL 2023
 Drawing No. A / DMC / P12 (REV. E)

AP's Signature
 I HEREBY CERTIFY THE ACCURACY
 OF THIS PLAN.

CHEUNG Man-Ching, Anthony
 Authorized Person (Architect)
 14-07-2023

LEGEND

SITE BOUNDARY

PHASE IIA
(CROSS-HATCHED PINK)

PHASE IIB
(CROSS-HATCHED GREEN)

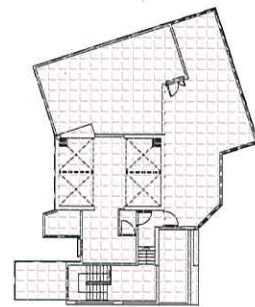

TOWER 1 (UPPER ROOF PLAN)

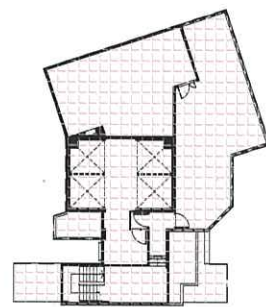

TOWER 2 (UPPER ROOF PLAN)

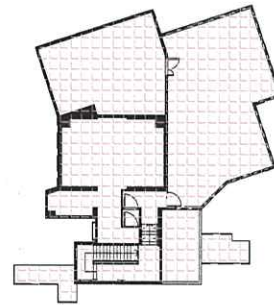

TOWER 3 (UPPER ROOF PLAN)

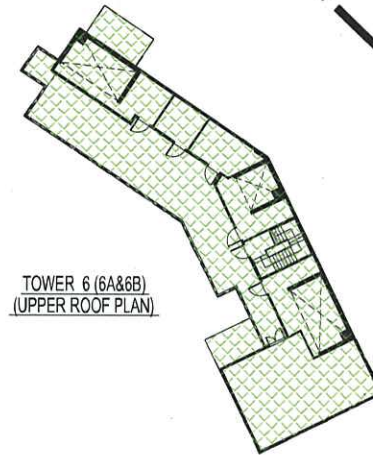

TOWER 6 (6A&6B)
(UPPER ROOF PLAN)



TOWER 5 (5A&5B)
(UPPER ROOF PLAN)

0m 5m 15m 30m

THIS PLAN IS FOR IDENTIFICATION PURPOSE ONLY



呂元祥建築師事務所

Project Title
HO MAN TIN STATION
PHASE II PROPERTY
DEVELOPMENT AT KIL. NO.
11264, HO MAN TIN, KOWLOON

Drawing Title
PHASING PLAN –
UPPER ROOF PLAN

Project No. 17025KL.01
Scale 1:500 Issue Date 14 JUL 2023
Drawing No. A/DMC/P13 (REV. E)

AP's Signature
I HEREBY CERTIFY THE ACCURACY
OF THIS PLAN.

CHEUNG Man-Cing, Anthony
Authorized Person (Architect)
14-07-2023

- LEGEND**
- — — — — SITE BOUNDARY
 - □ □ □ PHASE IIA
(YELLOW CROSSED LINE)
 - □ □ □ PHASE IIB
(GREEN CROSSED LINE)



TOWER 1 (TOP ROOF PLAN)

TOWER 2 (TOP ROOF PLAN)

TOWER 3 (TOP ROOF PLAN)

TOWER 6 (6A&6B)
(TOP ROOF PLAN)

TOWER 5 (5A&5B)
(TOP ROOF PLAN)

0m 5m 15m 30m

THIS PLAN IS FOR IDENTIFICATION PURPOSE ONLY



呂元祥建築師事務所

Project Title
**HO MAN TIN STATION
 PHASE II PROPERTY
 DEVELOPMENT AT KIL. NO.
 11264, HO MAN TIN, KOWLOON**

Drawing Title
 PHASING PLAN –
 TOP ROOF PLAN

Project No. 17025KL.01
 Scale 1:500 Issue Date 14 JUL 2023
 Drawing No. A/DMC/P14 (REV. E)

AP's Signature
 I HEREBY CERTIFY THE ACCURACY
 OF THIS PLAN.

CHEUNG Man-Ching, Anthony
 Authorized Person (Architect)
 14-07-2023



**NOISE MITIGATION MEASURES
IN PHASE II:**

ACOUSTIC WINDOW
(BAFFLE-TYPE)



ACOUSTIC BALCONY
(BAFFLE-TYPE)

FIXED GLAZING
WITH/WITHOUT
MAINTENANCE WINDOW



1/F-15/F PLAN OF TOWER 1
(12 STOREYS) (OMITTED 4/F, 13/F AND 14/F)



16/F-26/F PLAN OF TOWER 1
(10 STOREYS) (OMITTED 24/F)

0m 1m 3m 5m

THIS PLAN IS FOR IDENTIFICATION PURPOSE ONLY



呂元祥建築師事務所

Project Title
**HO MAN TIN STATION
PHASE II PROPERTY
DEVELOPMENT AT KIL. NO.
11264, HO MAN TIN, KOWLOON**

Drawing Title
TOWER 1 FLOOR PLANS (1)
NOISE MITIGATION MEASURES

Project No. 17025KL.01
Scale 1:200 Issue Date 14 JUL 2023
Drawing No. A/DMC/24 (REV. E)

AP's Signature
I HEREBY CERTIFY THE ACCURACY
OF THIS PLAN.

CHEUNG Man-Ching, Anthony
Authorized Person (Architect)
14-07-2023



NOISE MITIGATION MEASURES
IN PHASE II:

ACOUSTIC WINDOW
(BAFFLE-TYPE)



ACOUSTIC BALCONY
(BAFFLE-TYPE)

FIXED GLAZING
WITH/WITHOUT
MAINTENANCE WINDOW

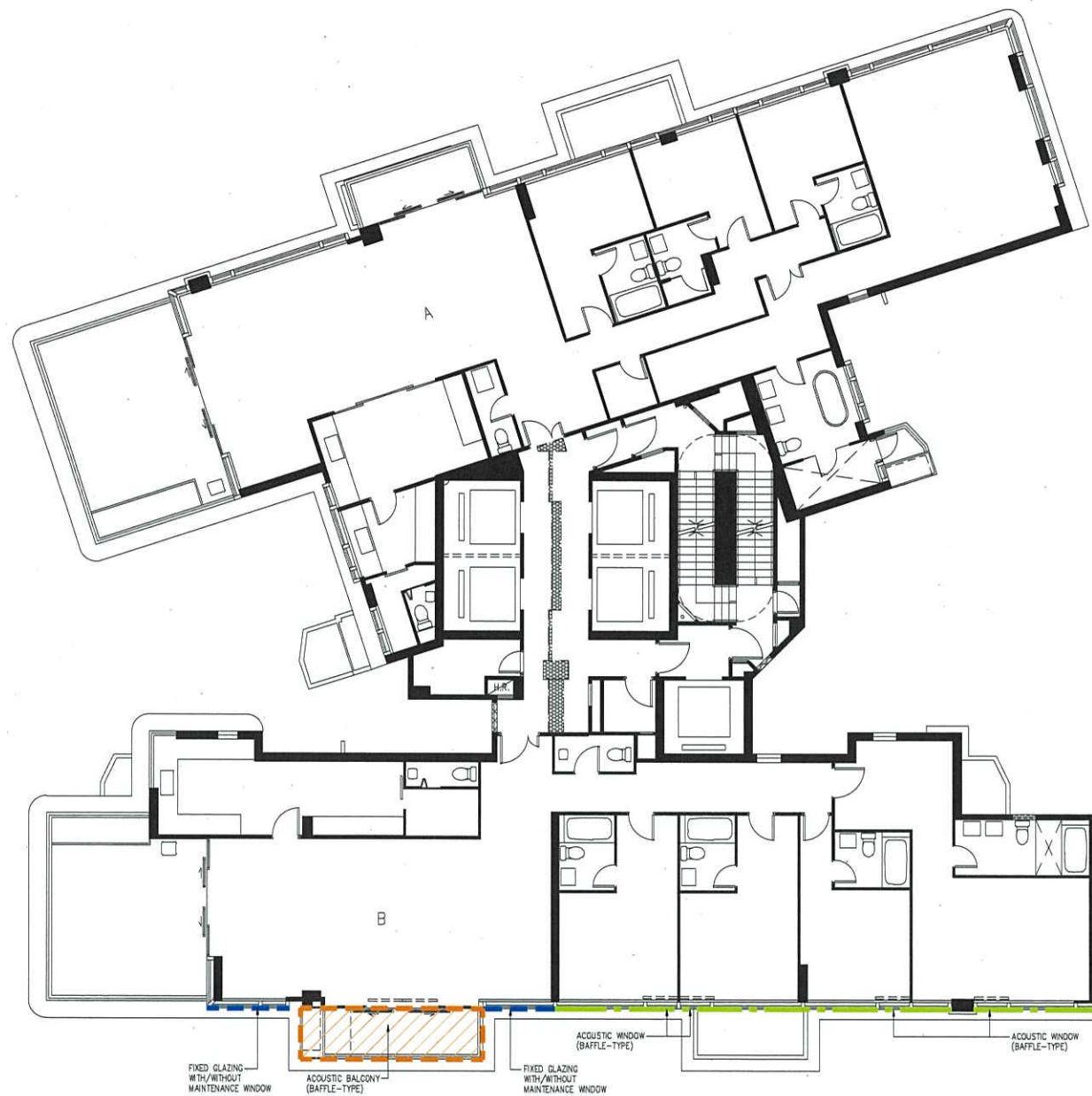

27/F PLAN OF TOWER 1

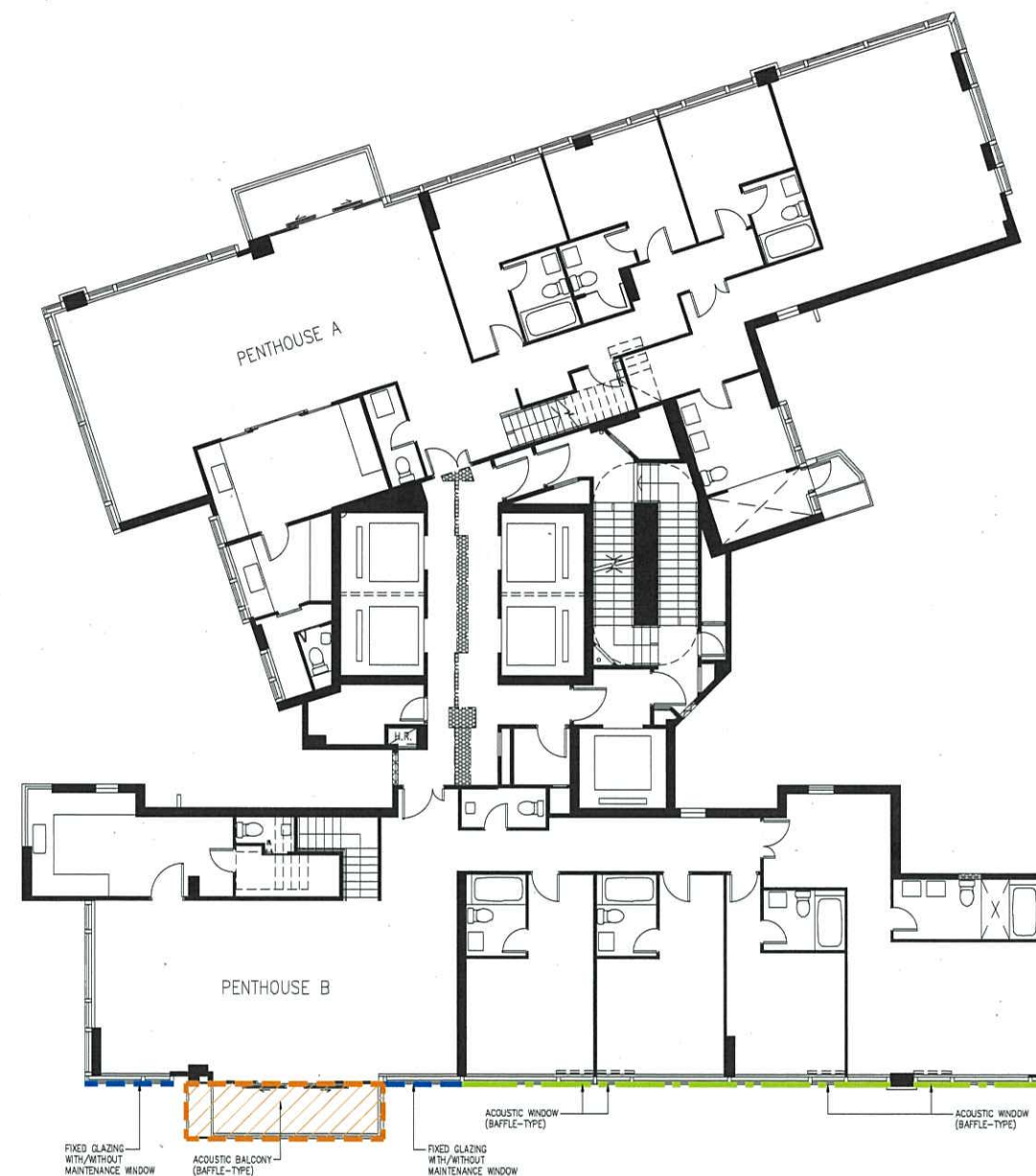

28/F PLAN OF TOWER 1

0m 1m 3m 5m

THIS PLAN IS FOR IDENTIFICATION PURPOSE ONLY



呂元祥建築師事務所

Project Title
HO MAN TIN STATION
PHASE II PROPERTY
DEVELOPMENT AT KIL. NO.
11264, HO MAN TIN, KOWLOON

Drawing Title
TOWER 1 FLOOR PLANS (2)
NOISE MITIGATION MEASURES

Project No. 17025KL.01
Scale 1:200 Issue Date 14 JUL 2023
Drawing No. A/DMC/25 (REV. E)

AP's Signature
I HEREBY CERTIFY THE ACCURACY
OF THIS PLAN.

CHEUNG Man Ching, Anthony
Authorized Person (Architect)
14-07-2023



**NOISE MITIGATION MEASURES
IN PHASE II:**

ACOUSTIC WINDOW
(BAFFLE-TYPE)



ACOUSTIC BALCONY
(BAFFLE-TYPE)

FIXED GLAZING
WITH/WITHOUT
MAINTENANCE WINDOW

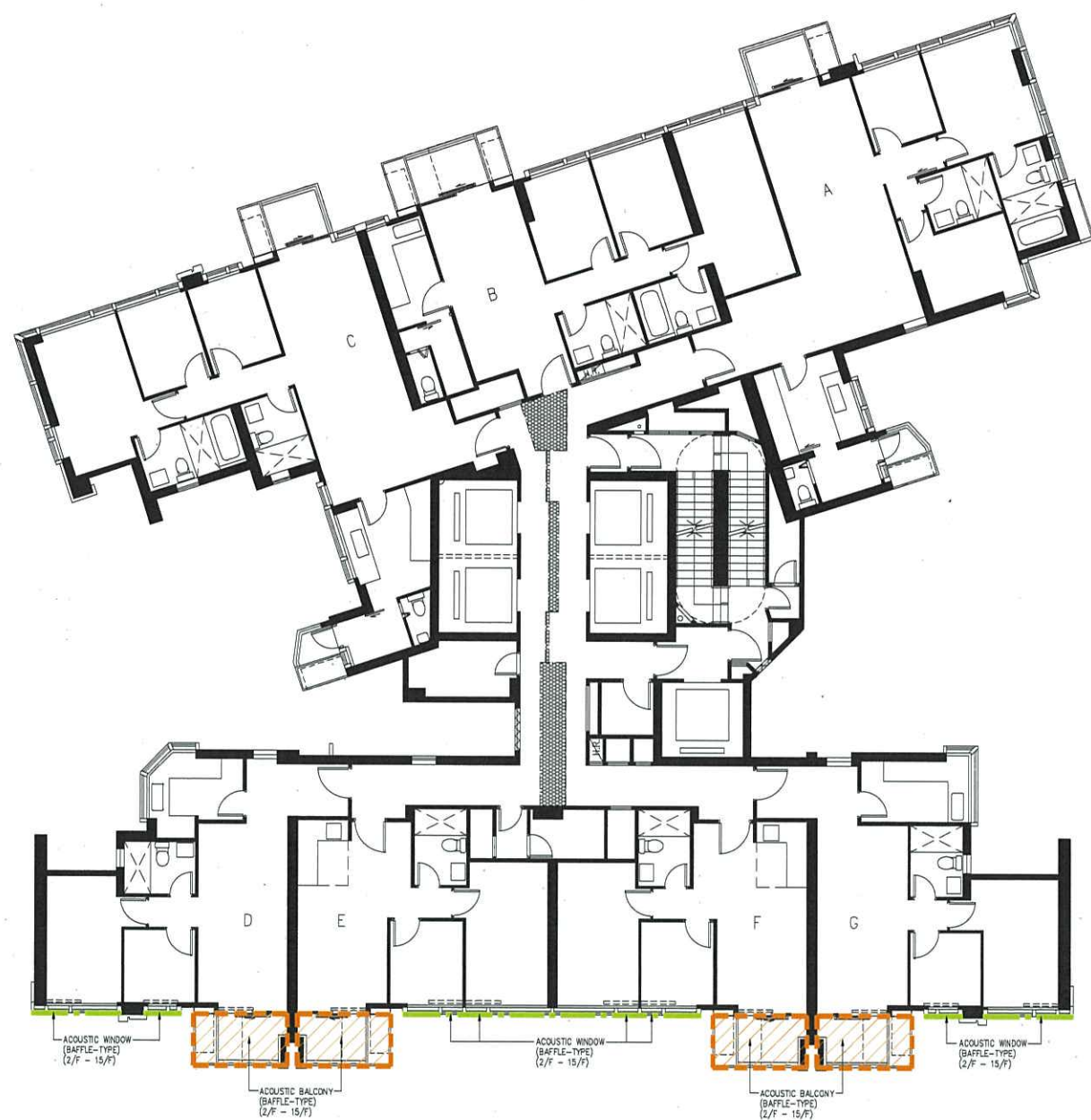

1/F-15/F PLAN OF TOWER 2
(12 STOREYS) (OMITTED 4/F, 13/F AND 14/F)



16/F-26/F PLAN OF TOWER 2
(10 STOREYS) (OMITTED 24/F)

0m 1m 3m 5m

THIS PLAN IS FOR IDENTIFICATION PURPOSE ONLY



呂元祥建築師事務所

Project Title
**HO MAN TIN STATION
PHASE II PROPERTY
DEVELOPMENT AT KIL. NO.
11264, HO MAN TIN, KOWLOON**

Drawing Title
TOWER 2 FLOOR PLANS (1)
NOISE MITIGATION MEASURES

Project No. 17025KL.01
Scale 1:200 Issue Date 14 JUL 2023
Drawing No. A/DMC/26 (REV. E)

AP's Signature
I HEREBY CERTIFY THE ACCURACY
OF THIS PLAN.

CHEUNG Man-shing, Anthony
Authorized Person (Architect)
14-07-2023



NOISE MITIGATION MEASURES
IN PHASE II:

ACQUSTIC WINDOW
(BAFFLE-TYPE)



ACQUSTIC BALCONY
(BAFFLE-TYPE)

FIXED GLAZING
WITH/WITHOUT
MAINTENANCE WINDOW



27/F PLAN OF TOWER 2



28/F PLAN OF TOWER 2

0m 1m 3m 5m

THIS PLAN IS FOR IDENTIFICATION PURPOSE ONLY



呂元祥建築師事務所

Project Title
HO MAN TIN STATION
PHASE II PROPERTY
DEVELOPMENT AT KIL. NO.
11264, HO MAN TIN, KOWLOON

Drawing Title
TOWER 2 FLOOR PLANS (2)
NOISE MITIGATION MEASURES

Project No. 17025KL.01
Scale 1:200 Issue Date 14 JUL 2023
Drawing No. A/DMC/27 (REV. E)

AP's Signature
I HEREBY CERTIFY THE ACCURACY
OF THIS PLAN.

CHEUNG Man-Ching, Anthony
Authorized Person (Architect)
14-07-2023



**NOISE MITIGATION MEASURES
IN PHASE II:**

ACOUSTIC WINDOW
(BAFFLE-TYPE)



ACOUSTIC BALCONY
(BAFFLE-TYPE)



FIXED GLAZING
WITH/WITHOUT
MAINTENANCE WINDOW



1/F-15/F PLAN OF TOWER 3
(12 STOREYS) (OMITTED 4/F, 13/F AND 14/F)



16/F-26/F PLAN OF TOWER 3
(10 STOREYS) (OMITTED 24/F)

0m 1m 3m 5m

THIS PLAN IS FOR IDENTIFICATION PURPOSE ONLY



呂元祥建築師事務所

Project Title
**HO MAN TIN STATION
PHASE II PROPERTY
DEVELOPMENT AT KIL. NO.
11264, HO MAN TIN, KOWLOON**

Drawing Title
TOWER 3 FLOOR PLANS (1)
NOISE MITIGATION MEASURES

Project No. 17025KL.01
Scale 1:200 Issue Date 14 JUL 2023
Drawing No. A/DMC/28 (REV. E)

AP's Signature
I HEREBY CERTIFY THE ACCURACY
OF THIS PLAN.

CHEUNG Man-Ching, Anthony
Authorized Person (Architect)
14-07-2023



NOISE MITIGATION MEASURES
IN PHASE II:

ACOUSTIC WINDOW
(BAFFLE-TYPE)



ACOUSTIC BALCONY
(BAFFLE-TYPE)

FIXED GLAZING
WITH/WITHOUT
MAINTENANCE WINDOW

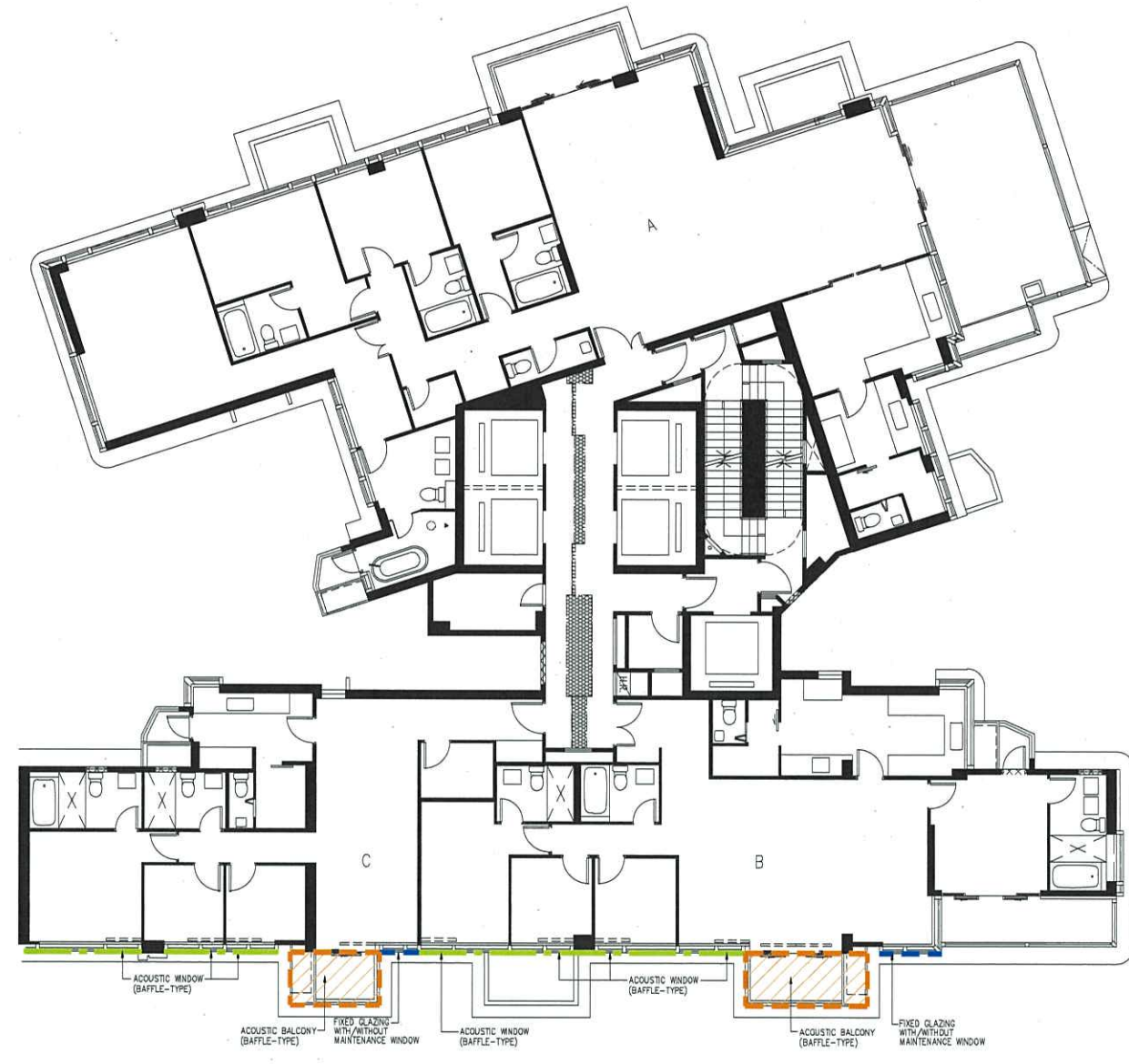

27/F PLAN OF TOWER 3



28/F PLAN OF TOWER 3



呂元祥建築師事務所

Project Title
HO MAN TIN STATION
PHASE II PROPERTY
DEVELOPMENT AT KIL. NO.
11264, HO MAN TIN, KOWLOON

Drawing Title
TOWER 3 FLOOR PLANS (2)
NOISE MITIGATION MEASURES

Project No. 17025KL.01
Scale 1:200 Issue Date 14 JUL 2023
Drawing No. A/DMC/29 (REV. E)

AP's Signature
I HEREBY CERTIFY THE ACCURACY
OF THIS PLAN.

CHEUNG Man Ching, Anthony
Authorized Person (Architect)
14-07-2023



THIS PLAN IS FOR IDENTIFICATION PURPOSE ONLY

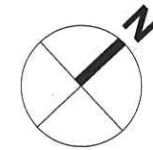

**NOISE MITIGATION MEASURES
IN PHASE I:**

ACOUSTIC WINDOW
(BAFFLE-TYPE)

ACOUSTIC BALCONY
(BAFFLE-TYPE)

FIXED GLAZING
WITH/WITHOUT
MAINTENANCE WINDOW

ACOUSTIC DOOR
(BAFFLE-TYPE)



0m 1m 3m 5m

THIS PLAN IS FOR IDENTIFICATION PURPOSE ONLY



呂元祥建築師事務所

Project Title
**HO MAN TIN STATION
PHASE II PROPERTY
DEVELOPMENT AT KIL. NO.
11264, HO MAN TIN, KOWLOON**

Drawing Title
**TOWER 5 FLOOR PLANS (1)
NOISE MITIGATION MEASURES**

Project No. 17025KL.01
Scale 1:200 Issue Date 14 JUL 2023
Drawing No. A / DMC / 30 (REV. E)

AP's Signature
I HEREBY CERTIFY THE ACCURACY
OF THIS PLAN.

CHEUNG Man-Ching, Anthony
Authorized Person (Architect)
14-07-2023

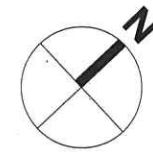

NOISE MITIGATION MEASURES
IN PHASE I:

ACOUSTIC WINDOW
(BAFFLE-TYPE)



ACOUSTIC BALCONY
(BAFFLE-TYPE)

FIXED GLAZING
WITH/WITHOUT
MAINTENANCE WINDOW



TOWER 5 (5B)

28/F PLAN OF TOWER 5 (5A&5B)

TOWER 5 (5A)

0m 1m 3m 5m

THIS PLAN IS FOR IDENTIFICATION PURPOSE ONLY



呂元祥建築師事務所

Project Title
HO MAN TIN STATION
PHASE II PROPERTY
DEVELOPMENT AT KIL. NO.
11264, HO MAN TIN, KOWLOON

Drawing Title
TOWER 5 FLOOR PLANS (2)
NOISE MITIGATION MEASURES

Project No. 17025KL.01
Scale 1:200 Issue Date 14 JUL 2023
Drawing No. A/DMC/31 (REV. E)

AP's Signature
I HEREBY CERTIFY THE ACCURACY
OF THIS PLAN.

CHEUNG Man Ching, Anthony
Authorized Person (Architect)
14-07-2023

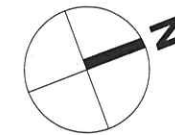

NOISE MITIGATION MEASURES IN PHASE II:

ACOUSTIC WINDOW (BAFFLE-TYPE)



ACOUSTIC BALCONY (BAFFLE-TYPE)

FIXED GLAZING WITH/WITHOUT MAINTENANCE WINDOW

ACOUSTIC DOOR (BAFFLE-TYPE)

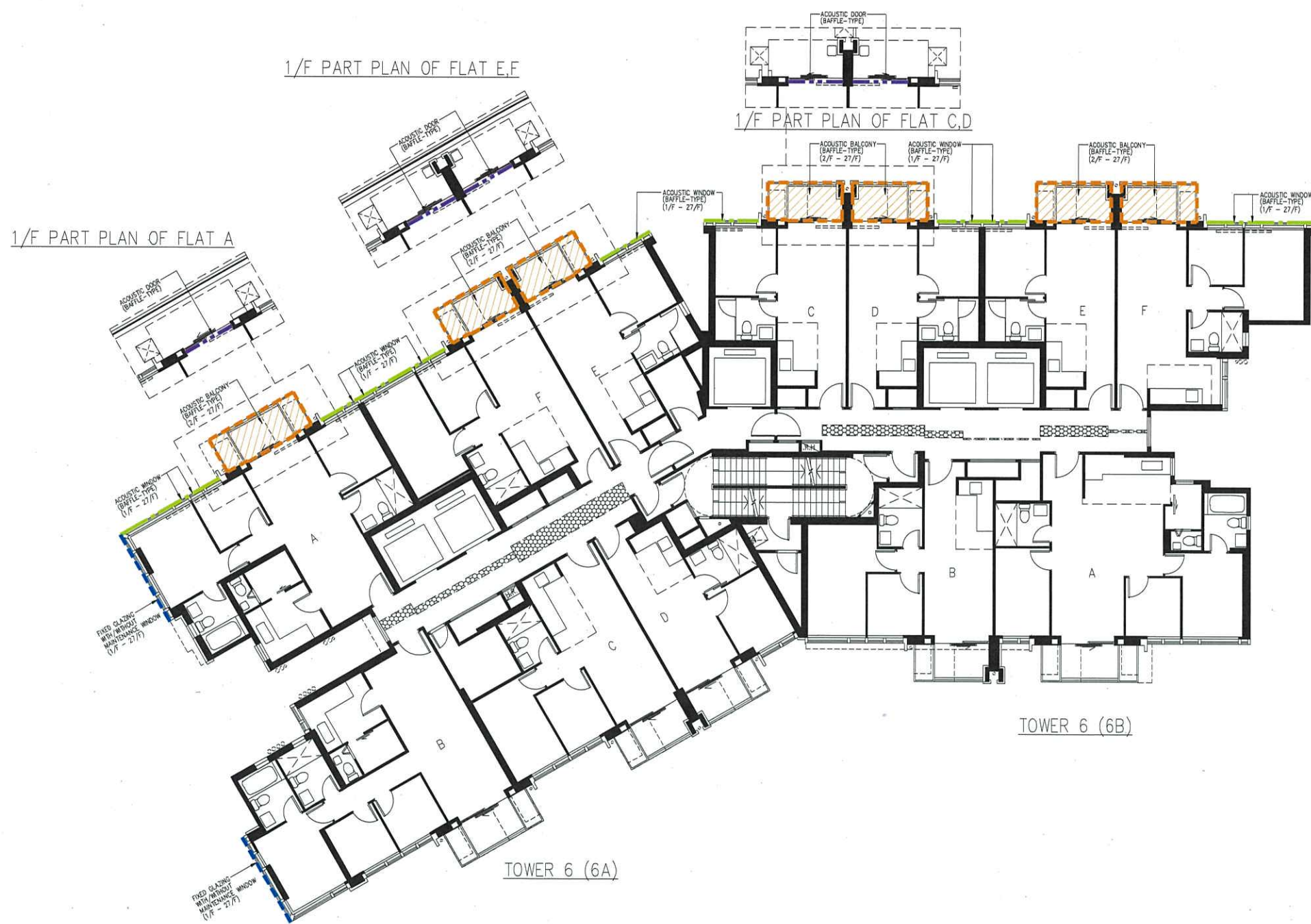

1/F-27/F PLAN OF TOWER 6 (6A&6B)
(23 STOREYS) (OMITTED 4/F, 13/F, 14/F AND 24/F)

0m 1m 3m 5m

THIS PLAN IS FOR IDENTIFICATION PURPOSE ONLY



呂元祥建築師事務所

Project Title
**HO MAN TIN STATION
PHASE II PROPERTY
DEVELOPMENT AT KIL. NO.
11264, HO MAN TIN, KOWLOON**

Drawing Title
**TOWER 6 FLOOR PLANS (1)
NOISE MITIGATION MEASURES**

Project No. 17025KL.01
Scale 1:200 Issue Date 14 JUL 2023
Drawing No. A/DMC/32 (REV. E)

AP's Signature
I HEREBY CERTIFY THE ACCURACY
OF THIS PLAN.

CHEUNG Man-Ching, Anthony
Authorized Person (Architect)
14-07-2023

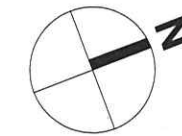

NOISE MITIGATION MEASURES
IN PHASE II:

ACOUSTIC WINDOW
(BAFFLE-TYPE)



ACOUSTIC BALCONY
(BAFFLE-TYPE)



FIXED GLAZING
WITH/WITHOUT
MAINTENANCE WINDOW



TOWER 6 (6B)

TOWER 6 (6A)

28/F PLAN OF TOWER 6 (6A&6B)



呂元祥建築師事務所

Project Title
HO MAN TIN STATION
PHASE II PROPERTY
DEVELOPMENT AT KIL. NO.
11264, HO MAN TIN, KOWLOON

Drawing Title
TOWER 6 FLOOR PLANS (2)
NOISE MITIGATION MEASURES

Project No. 17025KL.01
Scale 1:200 Issue Date 14 JUL 2023
Drawing No. A/DMC/33 (REV. E)

AP's Signature
I HEREBY CERTIFY THE ACCURACY
OF THIS PLAN.

CHEUNG Man-ching, Anthony
Authorized Person (Architect)
14-07-2023

0m 1m 3m 5m

THIS PLAN IS FOR IDENTIFICATION PURPOSE ONLY